

ThermoControl Plus 4

Eight controller circuits 1-stage
Four controller circuit 2-stage



Operating and Installation Manual



Schwank Group
P.O.Box 988 2 Schwank Way @ Hwy. 56N
Tel:1-877-446-3727 Fax: 1-866-361-0523
tsa@schwankgroup.com
www.schwankgroup.com

IM100630
RL:2
JUNE2010

Content:

1	INTRODUCTION	4
2	SAFETY.....	5
3	Display and Button Function	6
4	OPERATION	7
4.1	Basic operation	7
4.1.1	Further display information	7
4.1.2	Selection of a control zone.....	8
4.1.3	Activation and deactivation of a control-zone	8
4.1.4	Special information in the base display	8
4.2	Display and change of occupied / unoccupied temperature	9
4.3.	Display and modify time and date	10
4.4	Circuit/Zone Times	12
4.4.1	How to display and read a zone time program	12
4.4.2	How to clear a switch point	13
4.4.3	How to clear a time program	13
4.4.4	How to protect the time program	13
4.4.5	Program the switch points	14
4.5	Holiday program.....	15
4.6	Manual operation 	16
4.7	Button for service maintenance mode.....	16
5	SET UP THE OPERATING PARAMETERS.....	17
5.1	Enter the number of control zones	17
5.2	Set up system operation parameters	18
5.3	Adaptive heat recovery time	19
5.4	COPY	20
5.5	Securely save or reload all parameters	20
6	INSTALLATION	21
6.1	Electrical Supply	21
6.2	Sensor Connections	22
6.3	Heater Connection	22
	<u>Zone Configuration Diagrams</u>	
6.4	Standard Tube Heaters (single fire rate).....	22
6.5	Two-stage Tube Heaters	23
6.6	Luminous Heaters	23
6.6.1	Luminous Heaters - Jumper P1	24
6.6.2	Luminous Heaters - Jumper P2	25
6.6.3	Luminous Heaters - Jumper P3	26
6.6.4	Luminous Heaters - Jumper P4	27
6.6.5	Luminous Heaters - Jumper P5	28

6.7	Exhaust Fan Output - Two-stage Luminous Zones	29
6.8	Alarm Contact Input	29
6.9	Remote-Control ☀	29
6.10	Signal input fault	29
6.11	Temperature display °F / °C selection	29
6.10	Communication connection (CM232, CM485)	30
6.11	Common fault signals	30
7	TECHNICAL PARAMETERS	31
8	WIRING DIAGRAMS	33
8.1	Standard Tube Heaters: single- and two-stage zones	33
8.2	Two-stage Tube Heaters: two-stage zones	34
	Two-stage Tube Heaters: Internal Burner Wiring	35
8.3	Luminous Heaters: single-stage zones	36
8.4	Luminous Heaters: two-stage zones	37
8.5	Wiring Diagrams: Overrides, Humidity Control, Temp. Averaging	38
8.6	Temperature Sensor Characteristics	39

1 Introduction

The Schwank ThermoControl Plus 4 is suitable for single or two-stage gas-infrared heating systems.

Dependant upon its operation the controller has one or two controller circuits.

Please read this manual carefully before installing or using the control-unit. Failure to follow the notes and warnings will affect your guarantees. They are also a prerequisite for a professional installation and correct handling.

Please pay special attention to chapter 2 "Safety".

The ThermoControl Plus 4 is designed to be used for industrial/commercial building infrared heating systems only. Other or further uses are not suitable.

Schwank will not be held responsible for any damages whatsoever resulting from incorrect use.

The controller measures the radiant and ambient temperatures in the space and switches the heater(s) on/off by relays.

The controller features different operating programs.

-P1...P5: single- or two-stage controller for luminous gas-infrared heaters and tube heaters

Override day temperature mode ☀+h

Available as a special optional feature is a setback override button that manually extends the programmed heating period. This button is installed parallel to the sensor. By pushing the button (~1 sec.), the nominal value of the programmed temperature in the selected control circuit is maintained for an additional programmable time period. (Default 1h)

Programmed temperature values and operating programs

The temperatures and operating programs of each single control circuit are independently selectable.

- Day- ☀, night- ☾ or anti-freezing temperature * , selected by a week program
- Continuous day-(☀ **FIX**) night-(☾ **FIX**) or anti freezing temperature (* **FIX**).
- Holiday program: the controller is able to save eight holiday periods, which are programmed according to the calendar.

Other Tools/Features:

- Illuminated display
- Selectable °F / °C temperature display
- Button for service maintenance operation mode
- Real-time clock with calendar, including automatic summer / winter time correction
- Outdoor temperature sensor (SA)
- 'Smart' adaptive recovery: based on outdoor temperature, adjusts system ramp-up to ensure the desired occupied temperature is achieved at the programmed time.
- Remote controlled day-mode operation
- 'On' cycle record at each output
- Error-relay: relay switches on in any case of error

2 Safety



This is a 24VAC Class 2 low voltage (24Vac) temperature controller. Use only Class 2 rated power supply. Do not install on voltages higher than 30Vac.

Read all information in this manual before installing or programming the appliance. Electrical installation and wiring must conform to local and national building and electrical codes. Check the electrical equipment regularly. Defective wire etc. must be replaced immediately.

Be sure that power routed to the controller has been powered 'off' before beginning installation or installation of communication modules. Lock out the power supply.



The Schwank ThermoControl Plus 4 must be mounted where it is not affected by vibration or shock.

The feed/supply line must be protected by the installer with a fuse of maximum 16 A.

Install the ThermoControl Plus 4 ensuring conformity to the wiring diagram located in the switchboard.



Minimum Wiring Connection:

It is the installer's responsibility to ensure that wire gauge is sufficient to provide 24Vac from the transformer to the controller, and from the controller 24Vac outputs to the external relays that power heaters and exhaust fans. The distance between the power source and equipment must be considered.

- 24Vac power from 100VA transformer to the controller with minimum 16 AWG wire
- 24Vac from controller outputs to equipment power relays with minimum 16 AWG wire
- Connect sensor to controller with minimum 18 AWG wire



Install the IR temperature sensor between the radiant area of two heaters at a height of 6 ft (2 m) above floor. In this location the controller receives the optimal value of the comfort temperature (radiant temperature plus ambient temperature).

NOTE: If heating zones are dimensionally large in size or there are extreme temperature gradients within the zone, temperature averaging can be achieved using four IR sensors wired in parallel-series for each zone.

3 Display and Button Function

Front panel layout:

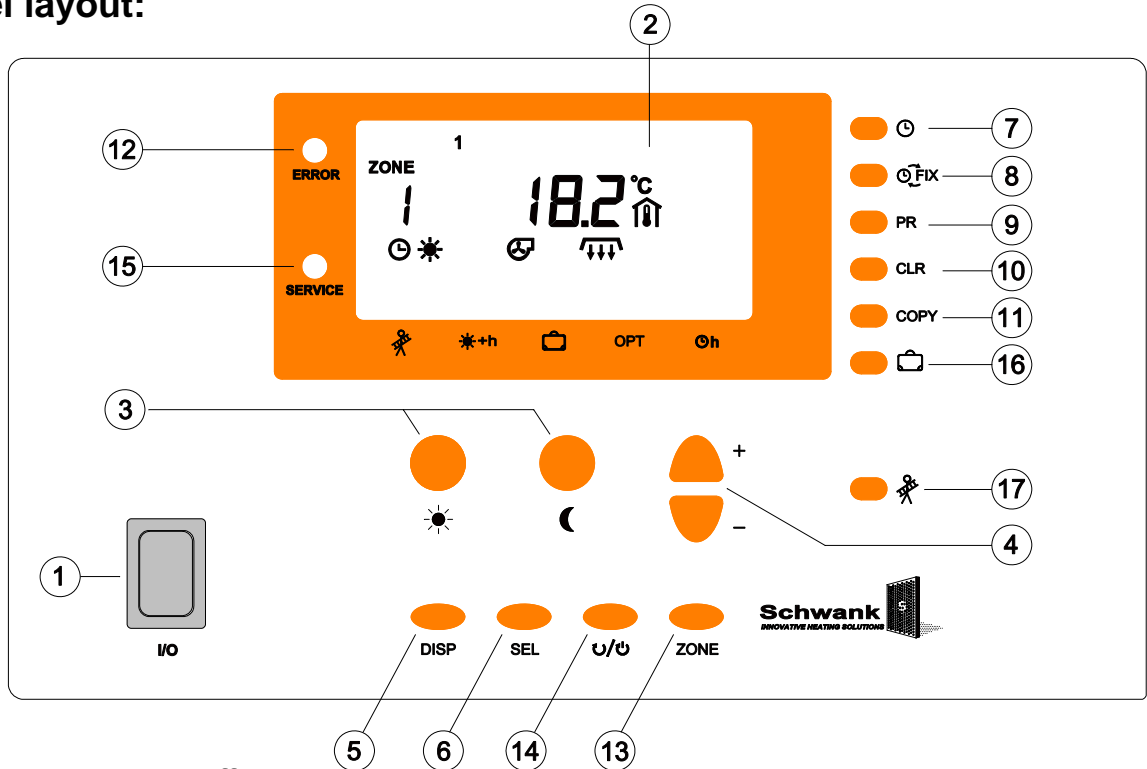

1. **I/O** Main switch on / off
2. **LCD** Display: All functional and operating information is shown in the base display mode (upper picture). If no button is pushed for more than one minute, the control unit switches back to the base display.
3. Push the button or the button to display the day or night set value. Use the **+/-** buttons to modify the values.
4. **+ / -** With these buttons the display values can be increased or decreased.
5. **DISP** “Display-button“: To change the display. This button also offers the ability to switch back to the main menu immediately.
6. **SEL** “SELECT“: This button allows selection of a certain parameter shown in the display. The chosen/selected parameter can be modified using the **+/-** buttons.
7. Clock-button: display and modify time and date.
8. Toggles between programmed and **FIXED** modes.
9. **PR** To check and modify the weekly time program in the displayed control circuit.
10. **CLR** “Clear-button“: To delete a switch-point or a complete time program.
11. **Copy** This button can be used to copy time- and temperature programs.
12. **ERROR** The system-error lamp flashes for any kind of error. An flashing sign will provide information about the cause.
13. **ZONE** To switch between different control circuits.
14. To turn on/off the single control circuit.
15. **SERVICE** “Maintenance“: If this appears, please call your service professional.
16. Button to program holiday operation mode.
17. Button for service maintenance operation mode: all control circuits heat full load.

4 Operation

4.1 Basic operation

When starting the ThermoControl with the I/O -button an automatic display-test is activated. The controller starts with the factory default program. The display then switches to the base-program, which shows all the important operation information.

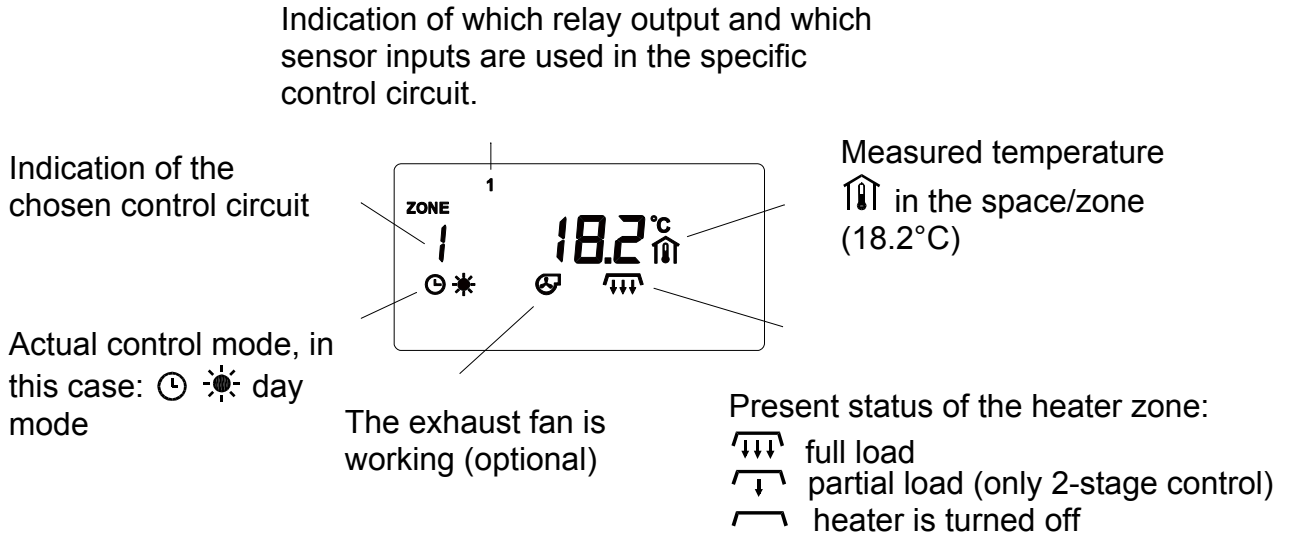

4.1.1 Further display information

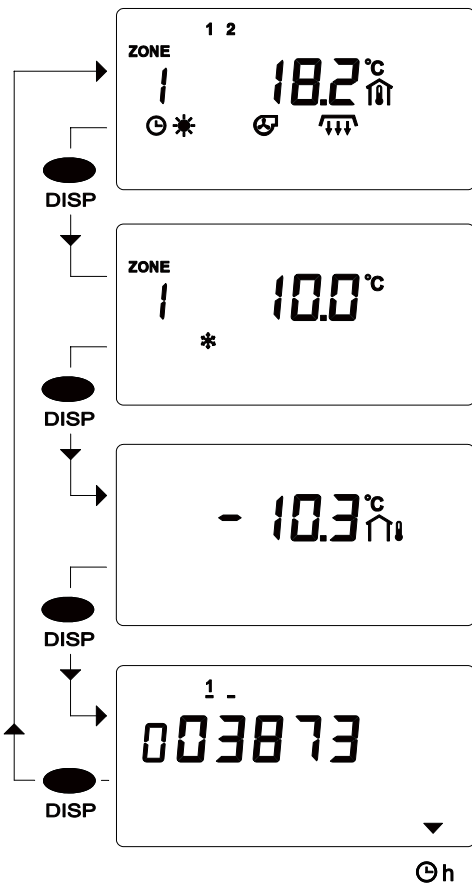

The main/base display gives all important operating data, further information can be received by pushing the **DISP** button.

Value of the entered freeze protection temperature *. The displayed value can be changed by the +/- buttons. Range of setting: +3 ... +20 °C / 37 ...68 °F

Display of the outside temperature (only if an outdoor temperature sensor SA is connected).

'On' cycle counter: The 2-stage control shows the circuit time of both stages.(1,2).

Push the **SEL** button to switch between the stages. The data cannot be deleted, after 999999 hours the display switches back to zero.

4.1.2 Selection of a control zone

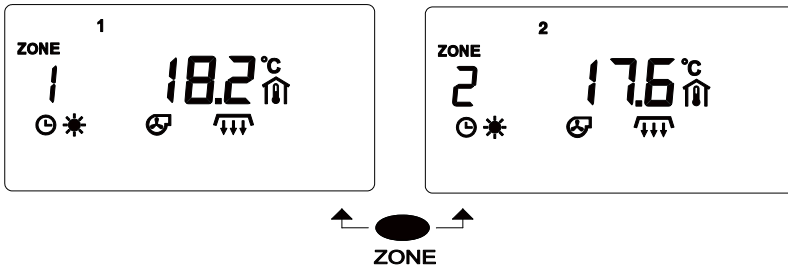

The controller display and its usage is based on the display of the control circuit. The control zone can be selected by pushing the **ZONE** button. All settings of the control zone can be managed.

4.1.3 Activation and deactivation of a control-zone

To stop heating in a certain zone: select the zone, and push the \cup/\cup button. The \cup symbol will indicate the deactivation of the zone. In the deactivated zone only temperature measurement and display continue to work. Activate the control zone again by pushing the \cup/\cup button.

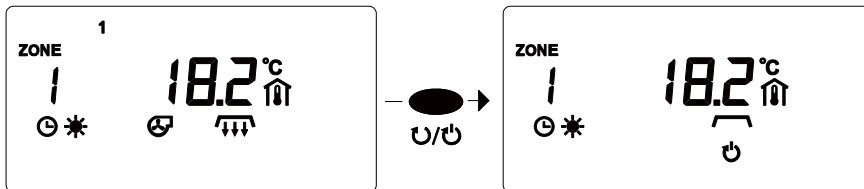

4.1.4 Special information in the base display

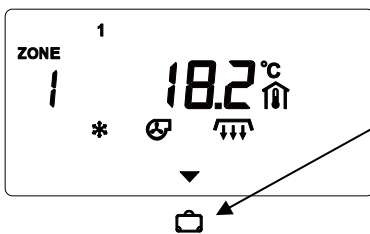

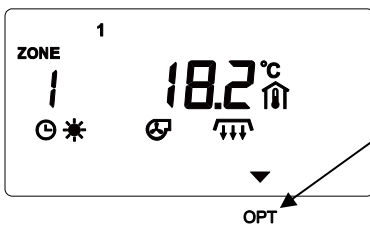

While using the holiday-mode the  symbol will appear.

To stop or modify the holiday program push the  button (chapter 4.5).

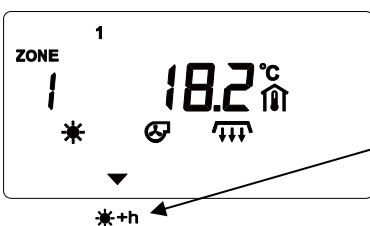

During adaptive heat recovery (optimised heat time) the **OPT** symbol appears. The activation time of a specific zone is dependent on the history of preheating performance compared to the entered heating time. This function can be deactivated only in the setup-menu. An outside sensor SA is required for this feature.



Option: By pushing the override button the occupied temperature mode starts for a pre-programmed time (0:00-24:00h; default 1h). The +h symbol will appear. The override mode can be stopped by using the  button.

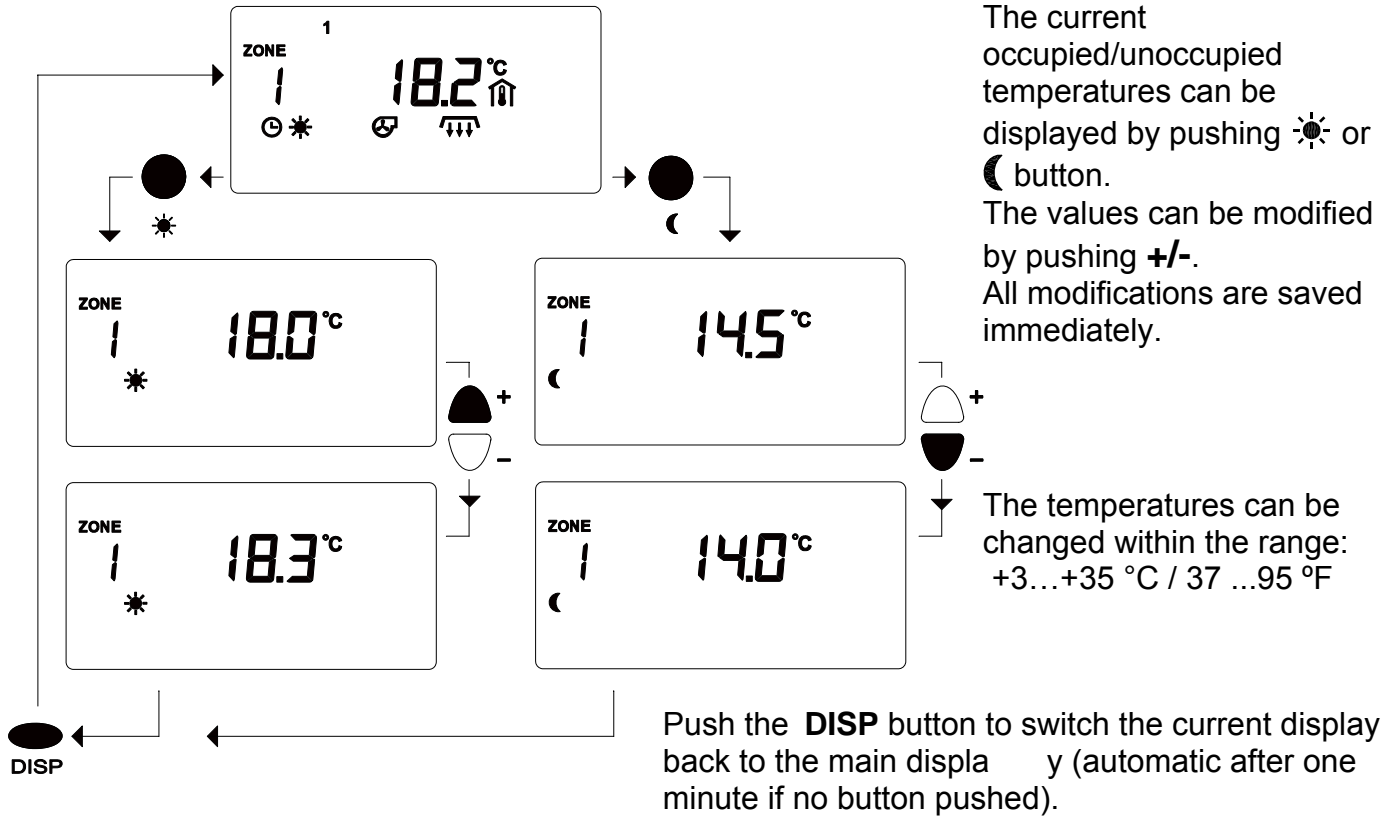

4.2 Display and change of occupied/unoccupied temperature

The desired temperature for each control circuit can be programmed separately



4.3. To display or modify the base time and date of the controller

Cycle through the base time and date of the controller with the  button. Modify any time or date using +/-.

This function affects the base controller clock (all control circuits have a separate time program). Push the  button to display/modify time of day (in the picture: 14:03). Push the  button again to display/change the year (2007). Push the  button a third time and the month and day (in this case: 3rd month = March, 21st day) is displayed. In the upper display, “3 Day” indicates the third day in the week, or “Wednesday”. (1= Monday, etc.)

Push the  button once more to switch the display back to the full normal clock display. Press the **DISP** button to return to the base display,.

Setting the time and date

NOTE: symbols or figures, shown framed are blinking!

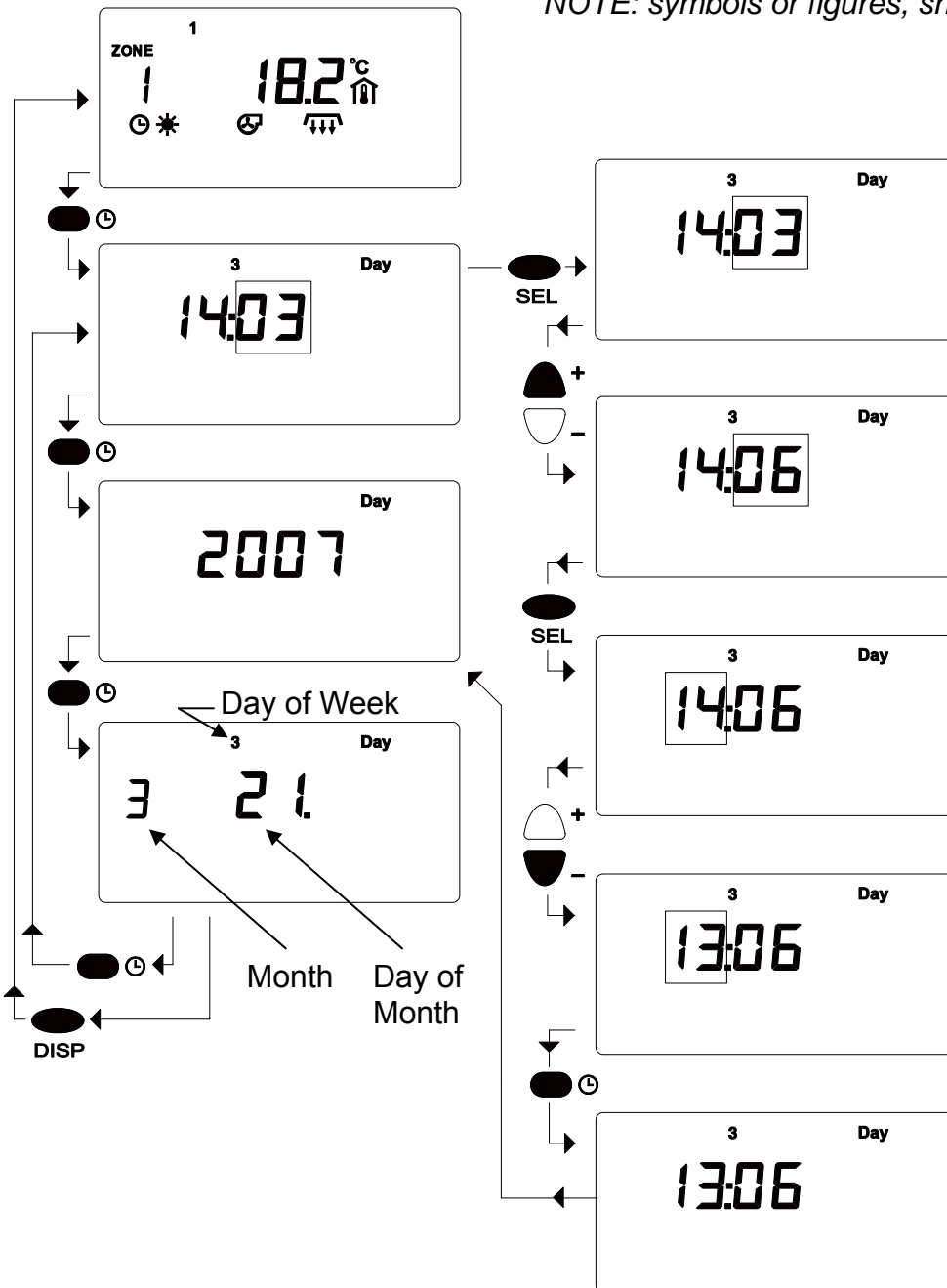

To change the time press the **SEL** button. First the minutes start to blink (03). Modified using +/-.

After pushing the **SEL** button again, the hours will start to blink. (14) The hour can also be changed with the +/- buttons.

The time of day setting is completed using the  button. The display returns to the year.

Set the year

After the time of day has been modified, set the correct year, month and day as well. Otherwise the automatic summer / winter time correction won't work properly.

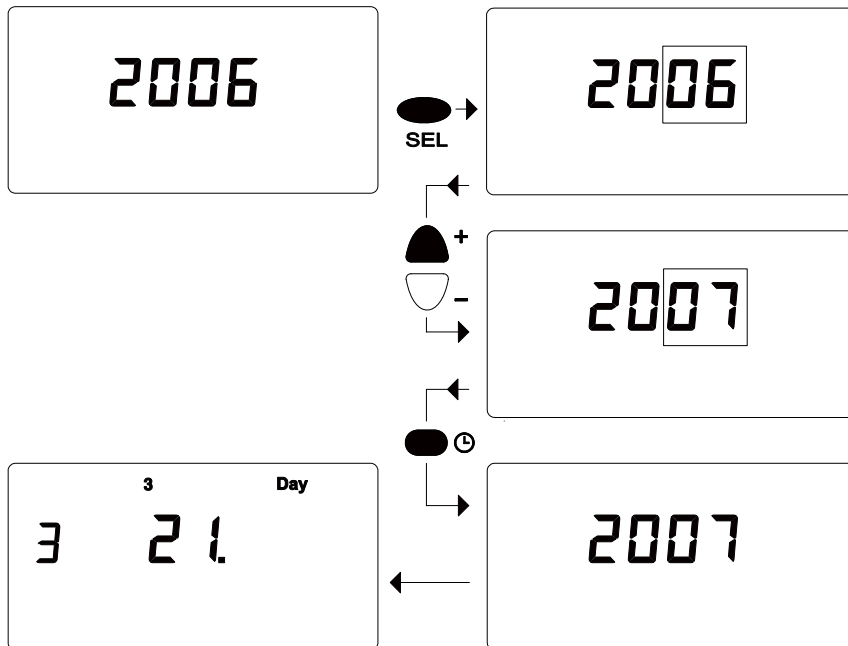

To change the year press the **SEL** button. The last two figures will start to blink (06). Modify with the **+/-** buttons.

Next push the button and month and day of the month respectively will be shown on the display. When the year has been modified, the day of the week may change according to the calendar (in this case 3).

Set the month and day

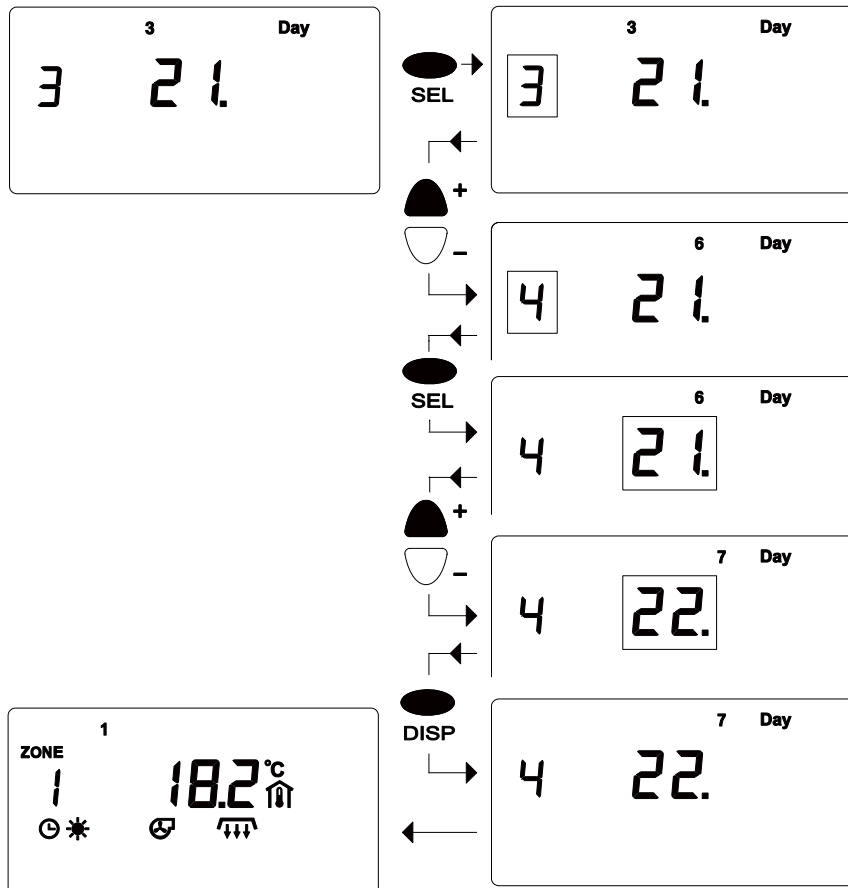

To change the setting press **SEL**. First the month (3) will start to blink - modify the setting with **+/-**.

To change the day of the month push the **SEL** button again. Now, the date starts to blink (21). Modify the date using **+/-**.

Once more the day of the week changes according to the calendar (first from 3 to 6, then to 7).

When the time/date setting is complete push **DISP**. The display switches back to the base display.

4.4 Circuit/Zone Times

Each control circuit has an independent time program, which can be set or modified. The time program is a series of different circuit times. The controller changes automatically from occupied (day) mode ☀, to unoccupied (night) mode ☾ or freeze protection mode *.

A circuit/zone point of time to switch modes can be described as:

- time of day (hour and minute)
- temperature mode ☀, ☾ or *, which will start at the set point of time
- day of the week, or a number of days, when the switch mode time should be active (1 = Monday, 2 = Tuesday 7 = Sunday)
- number of switch modes points of time (max. 19 times in one program)

4.4.1 How to display and read a zone time program

From the base display, to see the time program in the selected zone push the **PR** button.

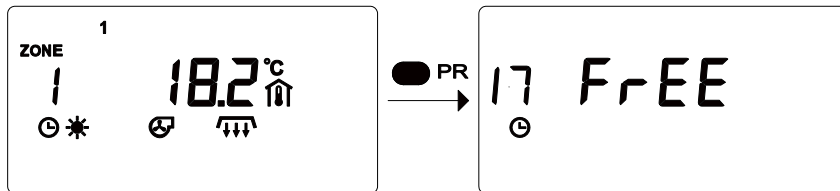

When you first press the **PR** button the display will briefly show the number of free switch point locations (here: 17 free points).

The display will then jump to the first programmed switch point. Press the **PR** button repeatedly to display the stored switch points one by one. Over the ☹ symbol the number of the switch point is displayed. The upper part of the display "1 2 3 4 5 Day" indicates which days of the week (1 = Monday...) the switch function occurs. With a few presses of the **PR** button you can see the full weekly heating program. Two examples are shown here:

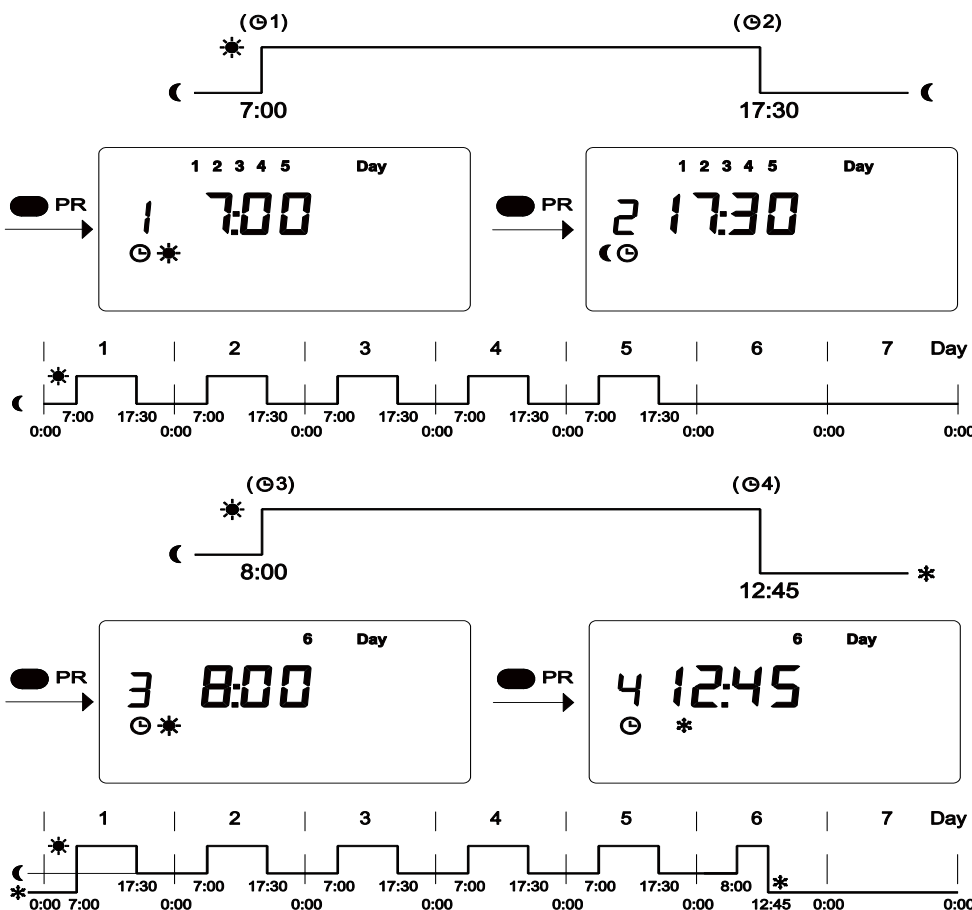

At switch time point 1 (7:00) day ☀ mode heating is started. Then at switch time point 2 (17:30) night ☾ mode heating begins. Since these two switch time points are valid on the first five days of the week (1 2 3 4 5 Day) and there are no other programmed switch time points for the last two days (6 7) the entire weekly program is described with these two switch time points.

In this next example the program is extended with two additional points: on Saturday (6 Day) at the point 3 (8:00) day ☀ mode heating starts. At point 4 (12:45) frost protection mode * begins. This mode will be active until the next programmed point 1 is reached on Monday.

4.4.2 How to clear a switch point

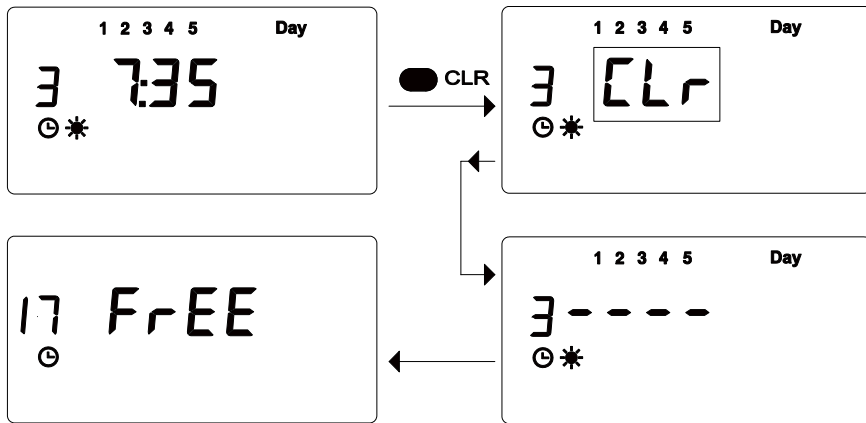

To clear or erase a switch time point: select the point, push and hold the **CLR** button. The symbol CLR will blink in the display, warning that a switch time point is to be cleared. If the **CLR** button is released immediately, then the erasure procedure will be stopped. If the erasure is completed horizontal lines are visible. Then the new number of free switch points is displayed.

The numeric of a switch point is not fixed. If a switch point is deleted the numbers of the remaining points will be reassigned so that there is no chance of gaps in the time program.

4.4.3 How to clear a whole time program

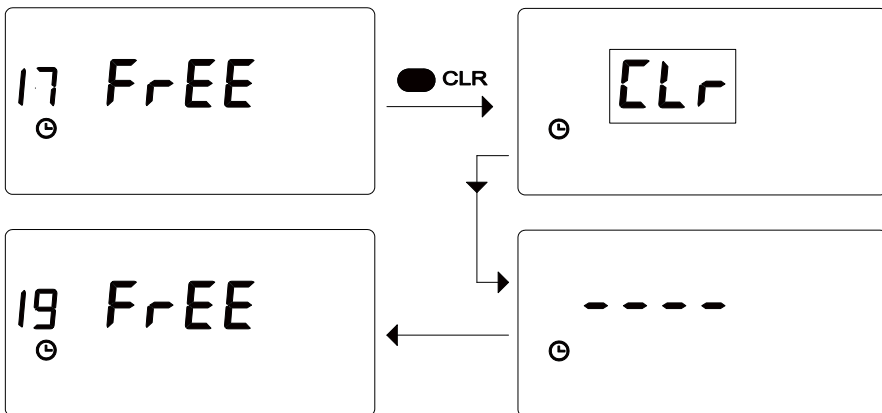

To clear a whole time program push and hold the **CLR** button while the number of free spaces are shown in the display (**FrEE**). The symbol CLR will start to blink as a warning. If the **CLR** button is released immediately, then the erasure procedure will be stopped. If the erasure is completed horizontal lines are visible. Then the new number of free switch points is displayed.(19).

4.4.4 How to protect the time program

The function of the time program is based on the clock and calendar data.

The clock is supplied by a battery (1.5 V AA). A warning signal  shows, when the battery needs replacement. For a 2 minute period while changing the battery, the exact time and date will remain intact.

In case the control-unit is not used for a long time, including a complete discharge of the batteries, the time and date will require confirmation of correctness or resetting after a battery change.

The saved switch points are independent of the battery. The program is saved on a secured EEPROM-memory. Time programs cannot be lost as a consequence of a battery change or discharge.

4.4.5 To program the switch points

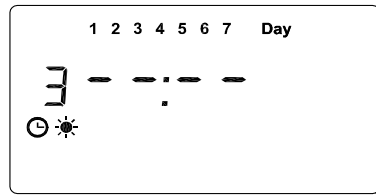

In this example we program the following criteria: The day temperature ☀ should start every morning at 7:35 from Monday through Friday. First search for a free switch point (- -: -) by using the **PR** button. Then press the **SEL** button and **+/-** to modify the new data. The same procedure can be used to modify existing switch points.

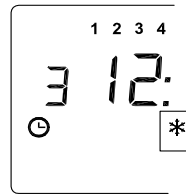
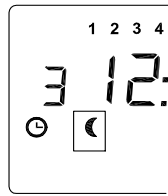
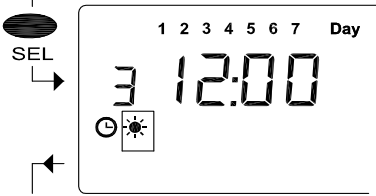

At first the temperature mode starts to blink. The mode ☀ or * can be selected using the **+/-** buttons.

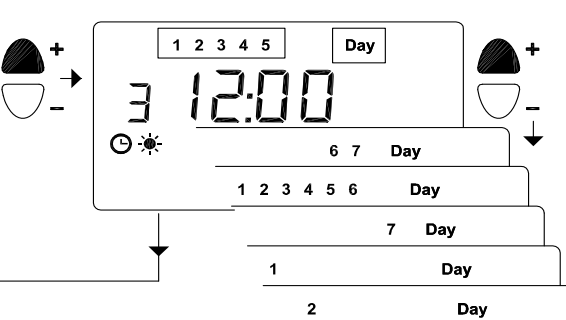
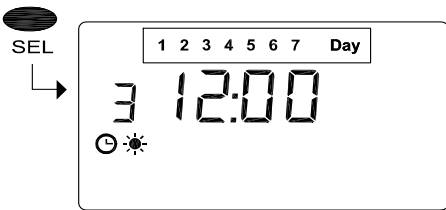

Then press the **SEL** button to select the day program. The entire week appears: 1234567. Pressing **+/-** selects different day groups or only single days (1=Monday).

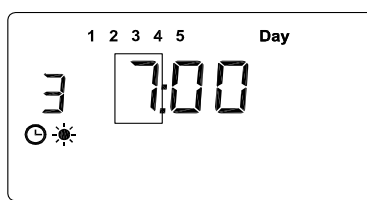
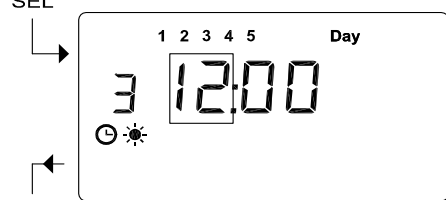

Next press the **SEL** button to modify the hour of the day (12). The required time (7) can be set with **+/-**.

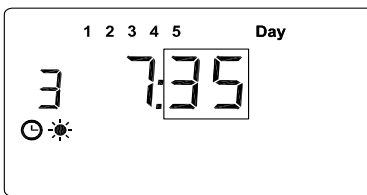
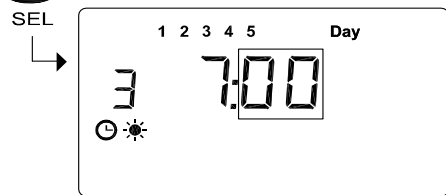

Then press **SEL** to select the minutes (00). The required time (35) can be set with **+/-**.

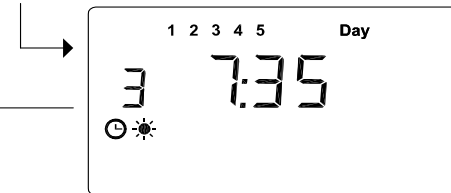
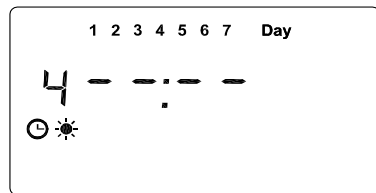

Finally press the **PR** button to set the switch time program. The display then changes to the next free switch point.

It is not possible to program two different switching points with the same time parameter. In the case of a mistake saving two switching points for the same time, the time of the last programmed point will be corrected by one minute.

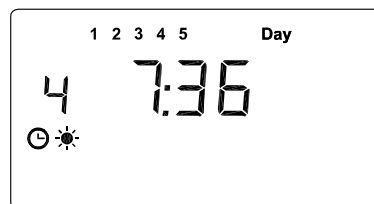

In this case a new switch point was programmed with a time of 7:35. This time parameter was used previously in switching point 3. Thus the time for point 4 changes automatically to 7:36.

4.5 Holiday program

The controller provides the opportunity to program 8 holidays. Start and end of the holiday is displayed with exact data (year, month, day). The programs can be changed and also stopped at every point of time.

During the holiday program the freeze protection temperature * will be maintained.

To program holiday periods push the  button.

First the number of the holiday program HOL 1 (holiday 1) appears. The numeric above the holiday number shows which of the 8 holiday programs is activated. A programmed holiday period starts automatically at the programmed date. Within the **SEL** button you are able to start or stop the programmed holiday period. If the program is switched off (program number does not appear) it won't start, a running program would be shut down respectively. Use **+/-** to select one of the 8 holiday programs.

The holiday program activates in all control circuits that are set to the automatic mode . If a control circuit is working on a fixed mode (FIX), the holiday program does not come into effect.

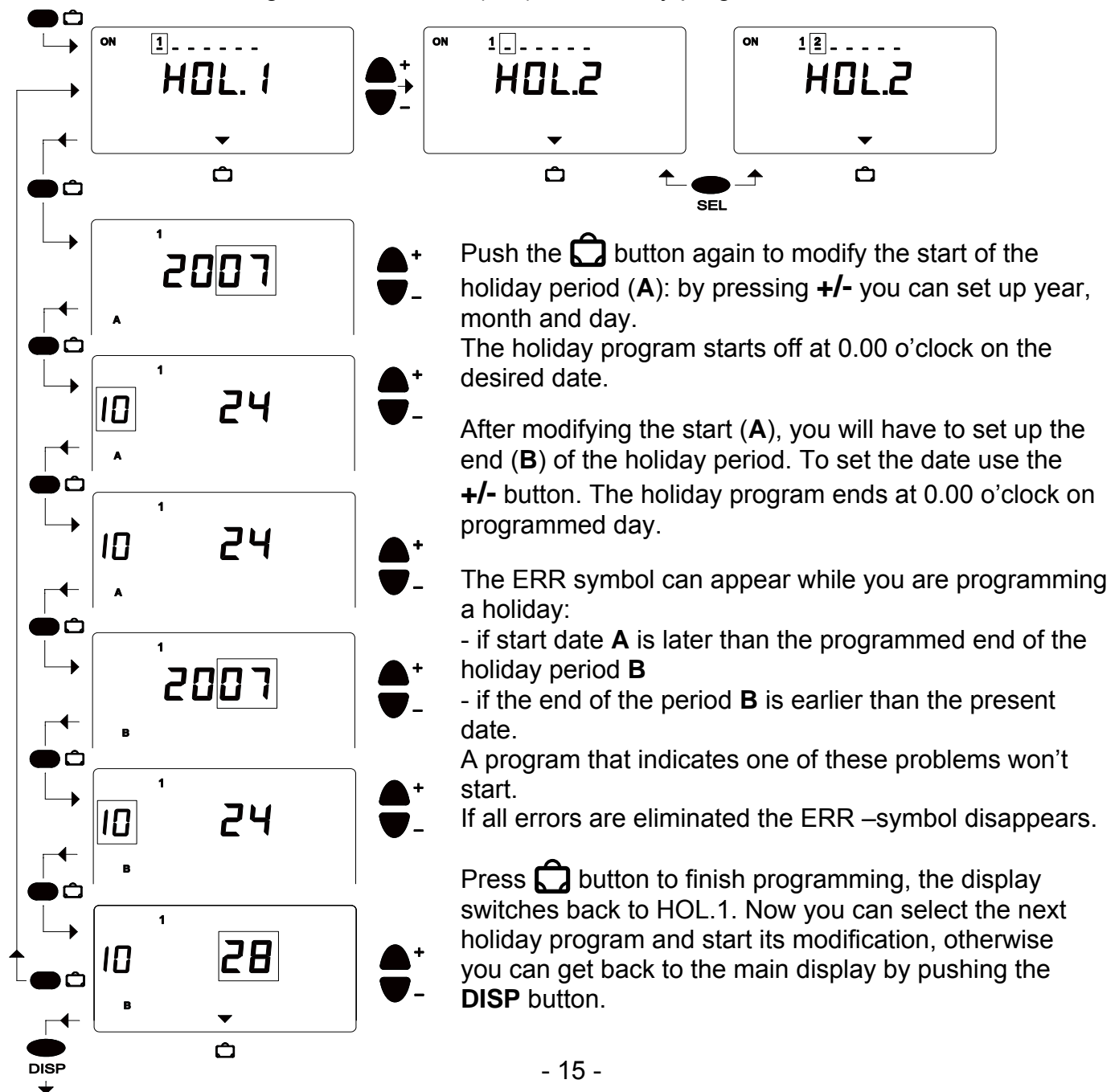

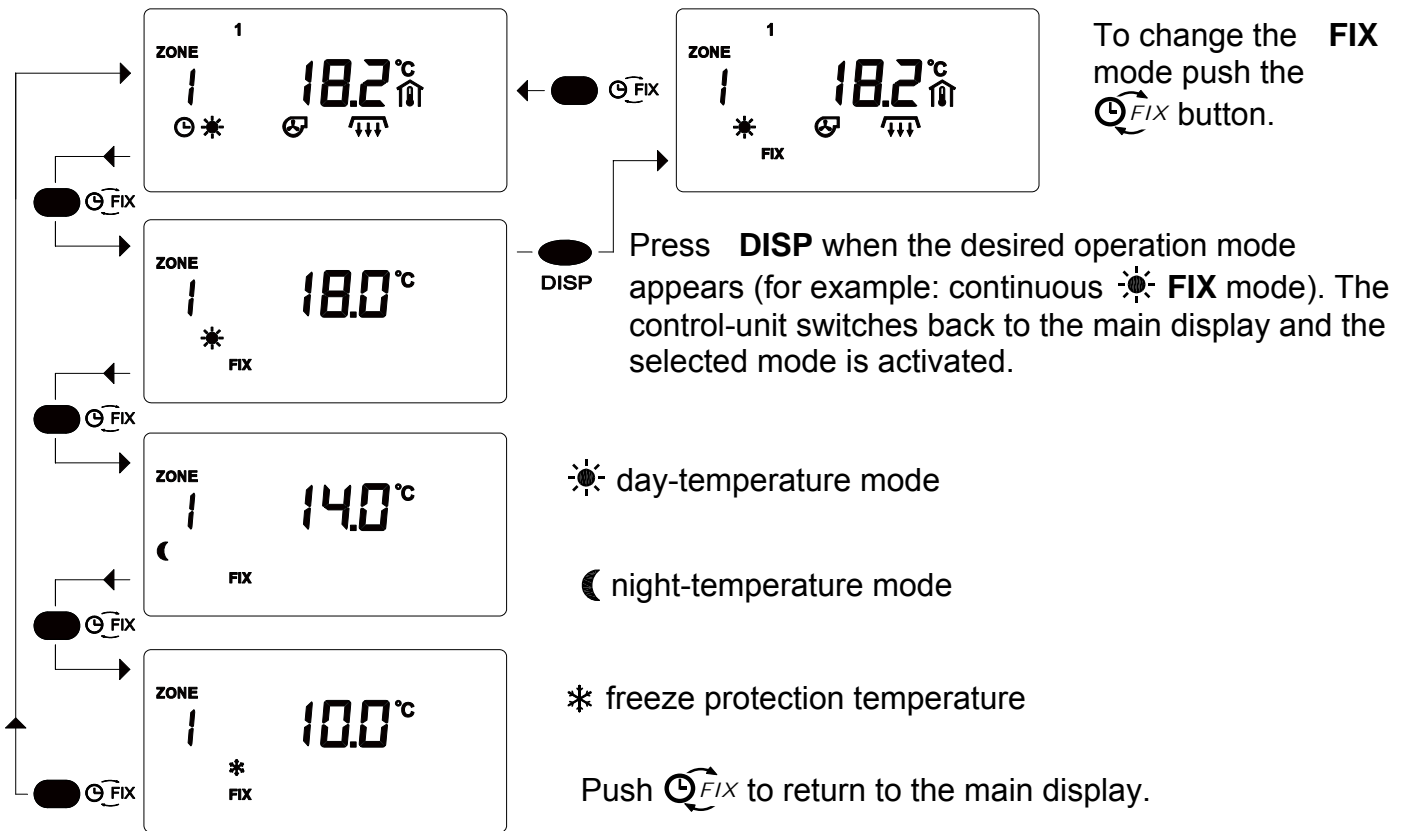

4.6 Manual operation

Use the  button to select different operating modes.

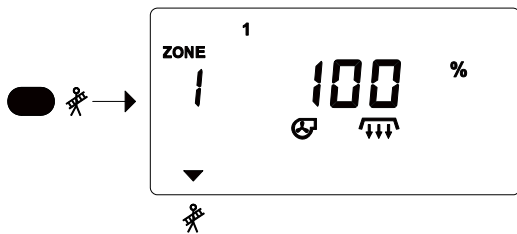

4.7 Button for service maintenance mode



For service or maintenance, to have the heater(s) in full operation regardless of the current room temperature, push the  **button**. Switch back to the base display mode by pushing this button again.

5 Set up the operating parameters

The “setup” switch as well as the jumper selection of the program P1 ... P5 may only be changed after the main power to the controller has been switched off. Before you open the control unit read the important information in chapter 2! The set up of operation parameters can be modified from the front panel with the “setup” switch in the “On” position. **Only a trained and knowledgeable technician should modify the operating parameters.** After setting up the operation parameters, turn off main power and switch the “setup” switch to the “Off” position to lock the parameters.

To access the setup switch: The switch permit setup: “ON”, locks the setup: “OFF”.

- **Switch off the main electrical supply before changing the switch position between “On” and “Off”.** It is not sufficient to switch off the I/O switch on the front panel of the controller, the external main switch must be switched off to avoid electric shock or possible damage to the module.
- Open the case cover door and loosen the four big plastic screws at the corners to release the outer enclosure case.
- Setup switch is located inside the outer enclosure case to the left side of the battery.

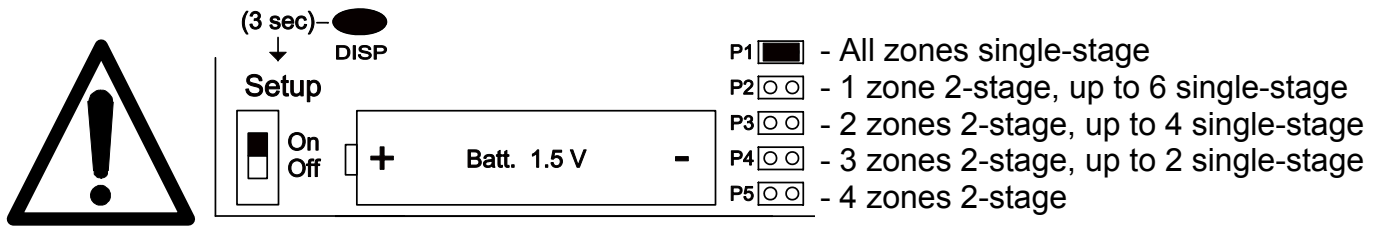

The application program is selected at the controller unit (P1, P2, P3, P4, P5). Perform this operation with the main power supply switched of. Place the “jumper“ in the correct position. Only one program can be selected at any one time. Double check that the jumper is positioned for the correct application program!

If the application program is changed (jumper moved) after set up, all parameters switch back to the default factory setting (chapter 5.1 and 5.2)!

P1 - Eight control circuits, single-stage

P2...P5 - Variations of control circuits - combines single- and two-stage zones

5.1 Enter the number of control zones

The controller is able to manage one or two control zones, depending on the chosen application. In the following example the actual number of control zones are set.

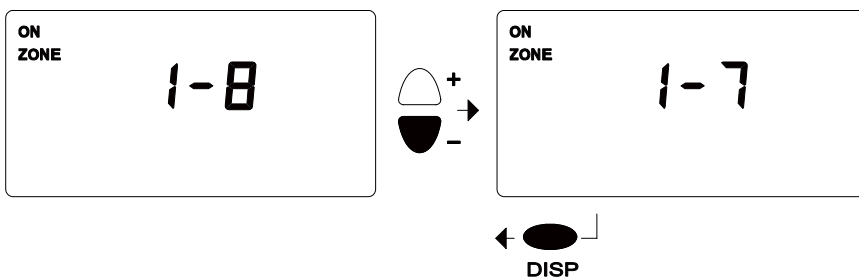

Hold the **ZONE** button for about 3 sec.. The number of available control circuits appears in the display (for example.: 1-8: four control circuits). The desired number of control circuits can be selected by pushing +/- (1-7).

Push the **DISP** button to return to the normal functions.

5.2 Set up system operation parameters (suggested settings are circled)

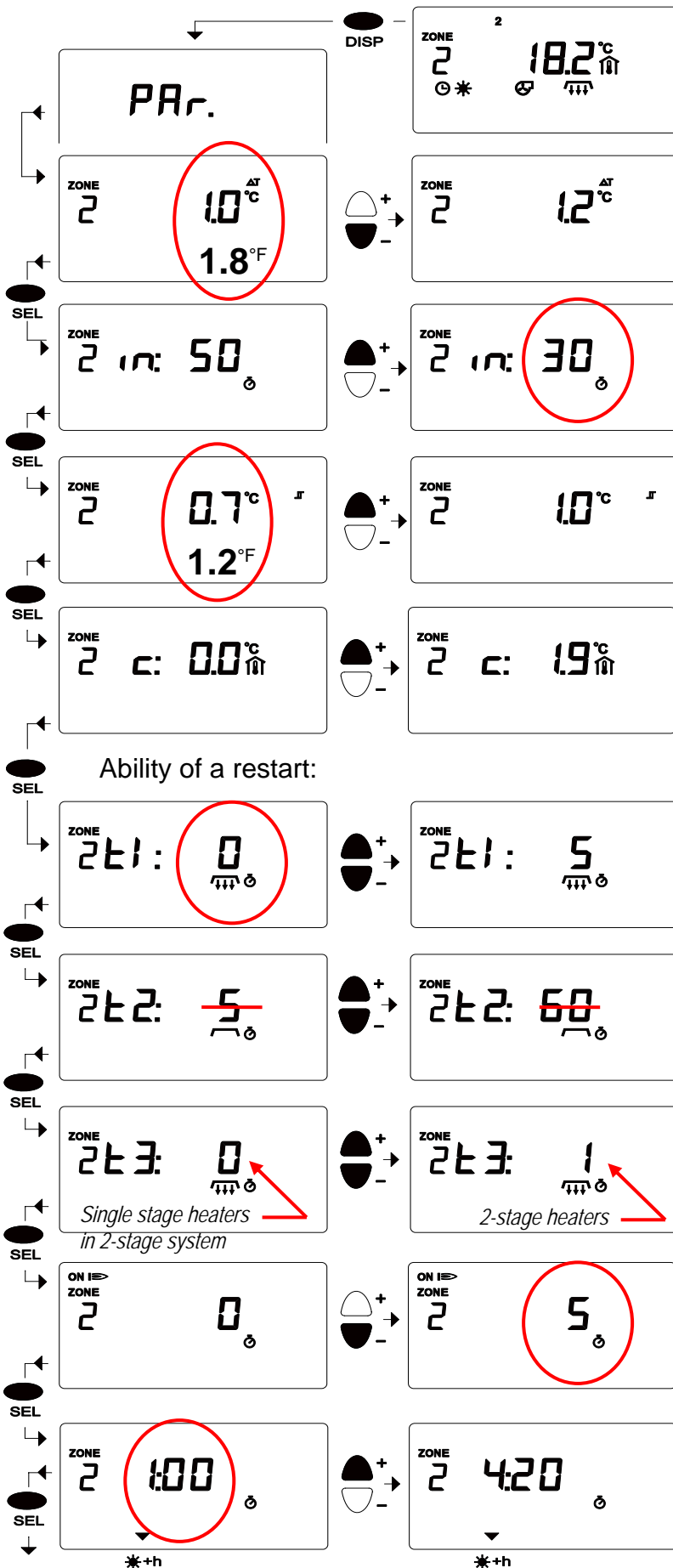

To set up the parameters hold the **DISP** button for approximately 3 seconds. The “PAR” symbol appears briefly. The operation parameters can be selected with the **SEL** button.

Proportional Gain: Two-stage mode only: 0.5...3.0 °C / 1.0...5.5 °F
Suggested Setting: 1.0°C / 1.8°F
 In single-stage mode: (---) appears

Integration time: Two-stage mode only: 10 ... 99 minutes
Suggested Setting: 30 minutes
 In single-stage mode, or in off-state (---) appears.

Hysteresis Π , can be activated by 0.2 ... 2.0 °C / 0.4...3.6 °F
Suggested Setting: 0.7°C / 1.2°F

Sensor correction: if the sensor could not be mounted at the optimal location, the measured temperature can be revised: -9.9..+10.0 °C / -9.9..+10.0 °F

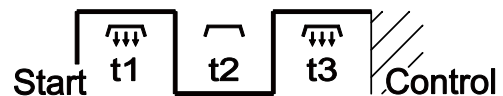

t1: Heater starts and runs at full power then stops at the programmed time, in this case: 0...5 minute.

t2: For the displayed time, the heater stops completely (5..60 Sec). it only appears, if t1 doesn't equal zero.

t3: Set to “0” for single stage heaters, set to “1” for 2-stage heaters. Heater starts at full load for 1 minute, then the controller switches to the regular mode (0: off). It does not appear unless the two-stage control is selected.

Minimum heater run time: (0...15 min)
Suggested Setting: 5 minutes

Override Duration: \odot +h (0:00-24:00)
Suggested Setting: 1:00 hour

Refer to sections 6.4 to 6.7 for exhaust fan output use

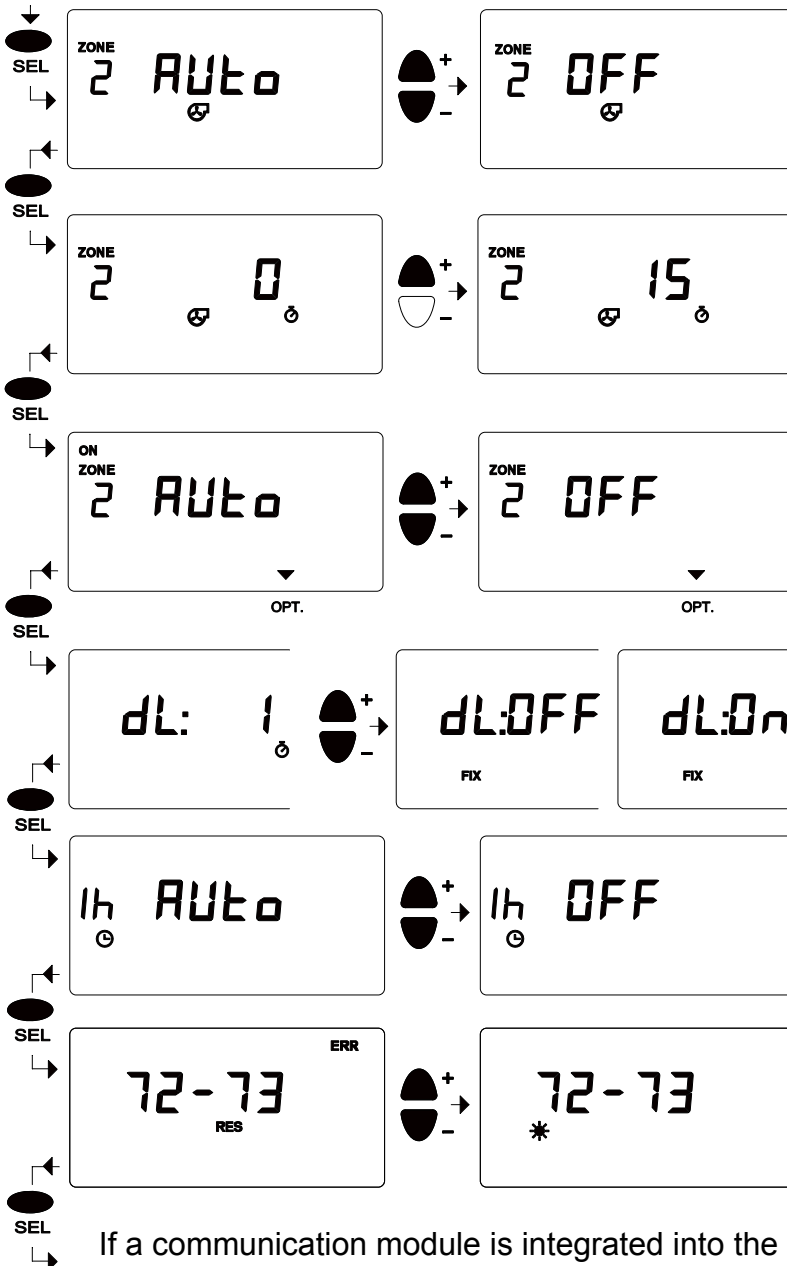

If a communication module is integrated into the controller, other parameters will follow.

Switch off exhaust fans:

'AUto': exhaust fan in use = for two-stage luminous zones ONLY, 'OFF': exhaust fan output is switched off for all tube heater zones, and single stage luminous zones (the ☞ symbol disappears).

Exhaust fan post-purge time ☞ :

After a heating zone (two-stage luminous) has been switched off, the exhaust fan can continue to run until the set time is achieved: 0 to 60 minutes (available only in the "AUto" ventilation mode).

Adaptive (Optimized) heat recovery time

can be switched on (AUto) or off(OFF). The effective warm up time is shown.

Display illumination duration:

1.....9 minutes; enable (ON) or disable (OFF) display illumination.

Auto switch summer to winter time

(+/- 1h). This function can be activated (AUto) or deactivated (OFF).

Feature selection of the contact input no. 72-73:

☀ : remote contact
RES-ERR: signal input - Error

5.3 Adaptive heat recovery time

The adaptive heat recovery time is active only if the sensor Outdoor Ambient Temperature Sensor **OAS** is connected to the controller, and the function is programmed to "Auto" in any heating zone. Each control circuit has a separate and individual adaptive heat recovery time. When set to "Auto" the program works automatically and doesn't need to be programmed or adjusted. The controller 'learns' and switches on the system to achieve occupied temperature ☀ at a different time than originally programmed, so that the desired temperature is achieved at the required time. The heating characteristics of the heating zone and temperature difference from inside to the current outside temperature are integrated in the calculation for the recovery time. The control unit adjusts the start point of the recovery time to the current situation.

5.4 COPY

The **COPY** button offers the opportunity to copy all parameters of a certain circuit or the complete time program and insert it into the program of one or many other control circuits.

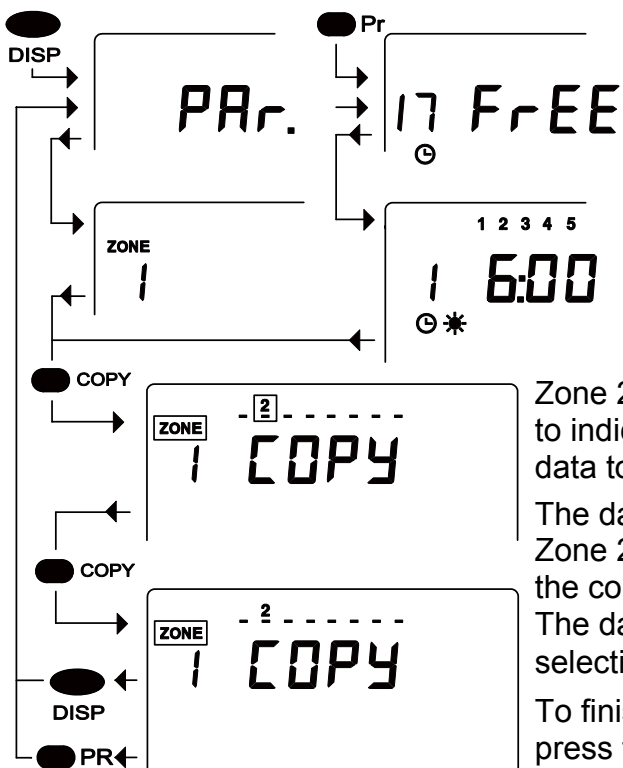

To copy parameters hold **DISP** (approx. 3 sec., chapter 5.2).

To copy time programs use the **PR** button (chapter 4.4.1).

This example copies data from Zone 1 to Zone 2.

Push either the **DISP** (parameters) or **PR** (time program) button

Zone 2 symbol start to blink. "COPY" appears in the display to indicate the copy mode. Push **COPY** to paste the Zone 1 data to Zone 2 (heating area 2).

The data of Zone 1 is now also located in Zone 2. The Zone 2 symbol stops blinking to indicate the completion of the copy process.

The data can continue to be copied to other Zones by selecting Zone 3 to Zone 8 using the **SEL** button.

To finish copying the parameters press **DISP** button, or press the **PR** button to finish copying time programs.

5.5 To securely save or reload all parameters:

The setup technician can save all operational parameters to memory. If the parameters are changed unintentionally, the old parameters can easily be re-established using the data saved in memory. It is also possible to reload the factory default settings.

To Save: Press **CLR** and **+** simultaneously. The "SAVE" symbol appears in the display. Push **DISP**, the display will blink while the parameters are saved. Once saved the display switches back to the main menu.

To Load: Press **CLR** and **SEL** simultaneously, the "LOAD" symbol appears in the display. Press the **DISP** button and the parameters that were saved by the setup technician, will reload. Switch from "LOAD" to "FACT", using the **+/-** button. If "FACT" appears in the display push the **DISP** button to re-establish the factory default parameters.

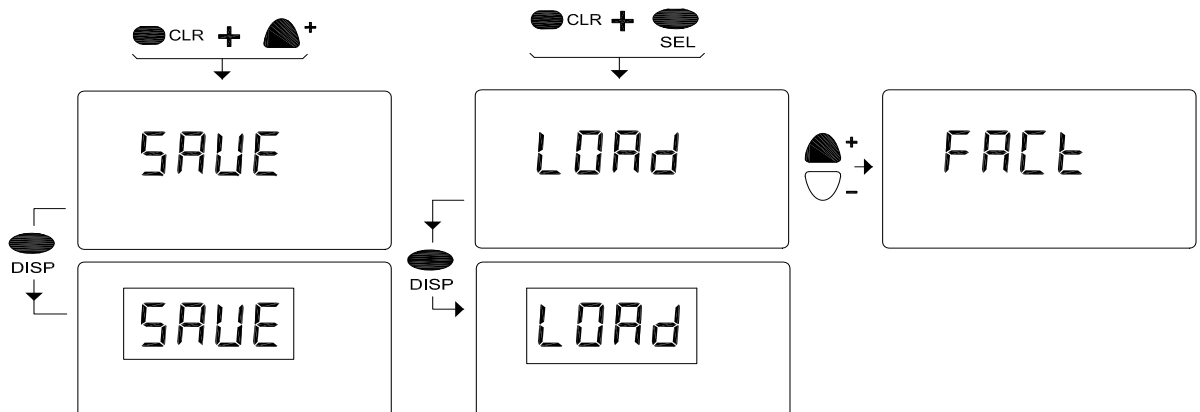

6 Installation & Configuration

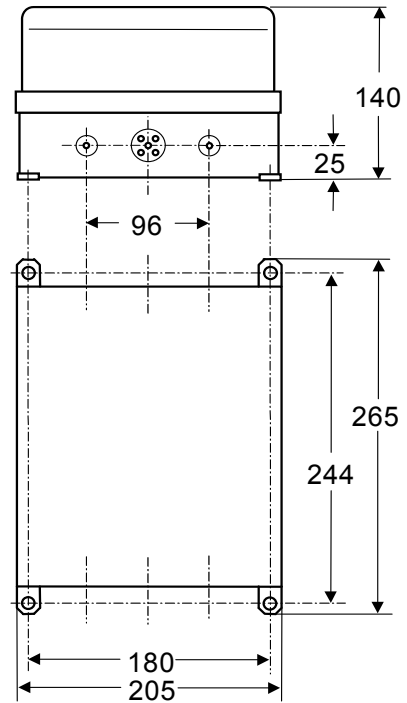
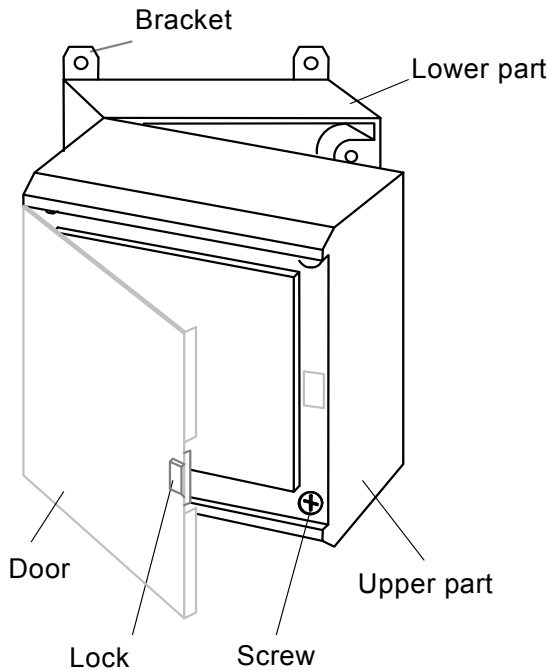

6.1 Electrical Supply



The controller must be electrically grounded in accordance with the National Electrical Code, ANSI / NFPA 70 or current Canadian Electrical code CSA C22.1. Appliance and control wiring must be in accordance with all applicable local codes.

The controller must be isolated from the main power supply during installation or connection work is carried out! The "Off" position (O) of the controller I/O switch does not provide complete isolation of the controller!

The controller power supply connection terminals are identified as "L 24v" and "COM". The "COM" connection point is the common ground in the circuit: it is directly connected to the points of the relay outputs marked "C", and it is the common point of the signal input terminals and the communication terminal. The "L 24v" power supply is connected through a Fuse (6.3A) to the connection terminal "L1". **It is important to make connections correctly in accordance with the wiring schemes of the selected application program!**

Pay special attention to common ground when connecting outside devices so that a short-circuit does not occur.

If several ThermoControl units are connected to one 24VAC power supply, ensure to connect the same terminals of the power supply to the "L24v" and "COM" terminals of the controllers.

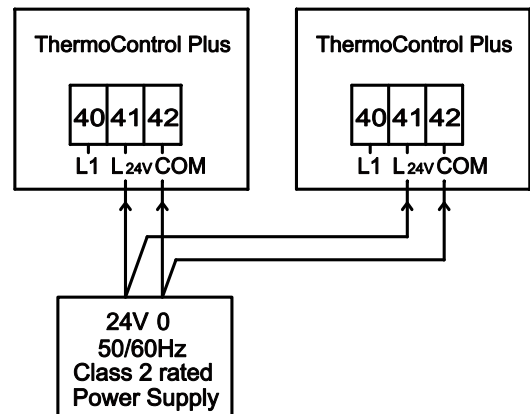

6.2 Sensor connections

The sensor is connected with two wires. The sensor does not require shielded cable, because the controller includes effective protection. The length of wire up to 650 ft (200 m) does not influence the accuracy of the temperature measurement. Do not run the sensor lead next to high voltage wires. The sensor connection must match the selected operating program (single- and/or two-stage zones). Unused inputs must be kept free of usage!

6.3 Heater Connection

Only 24Vac Class 2 equipment can be connected to the controller! The controller interior relays switch 24Vac to the connection terminals (wet contact). Use 24Vac Class 2 rated power relays to control heaters and ancillaries. Note that the total load is limited to 6.3 A.

6.4 Zone Configuration – Standard Tube Heaters (single firing rate)

Standard tube heater zones can be set up as single-stage, or two-stage. Two-stage zones have a proportion of the heaters on low-stage, with the balance of the heaters in the zone on high-stage. Refer to sections 5 and 5.2. A zone can contain up to ten standard tube heaters. The location of the jumper in P1 ... P5 determines the quantity of single-stage and two-stage zones. Refer to configuration diagram below and wiring diagram (8.1) for standard tube heaters.

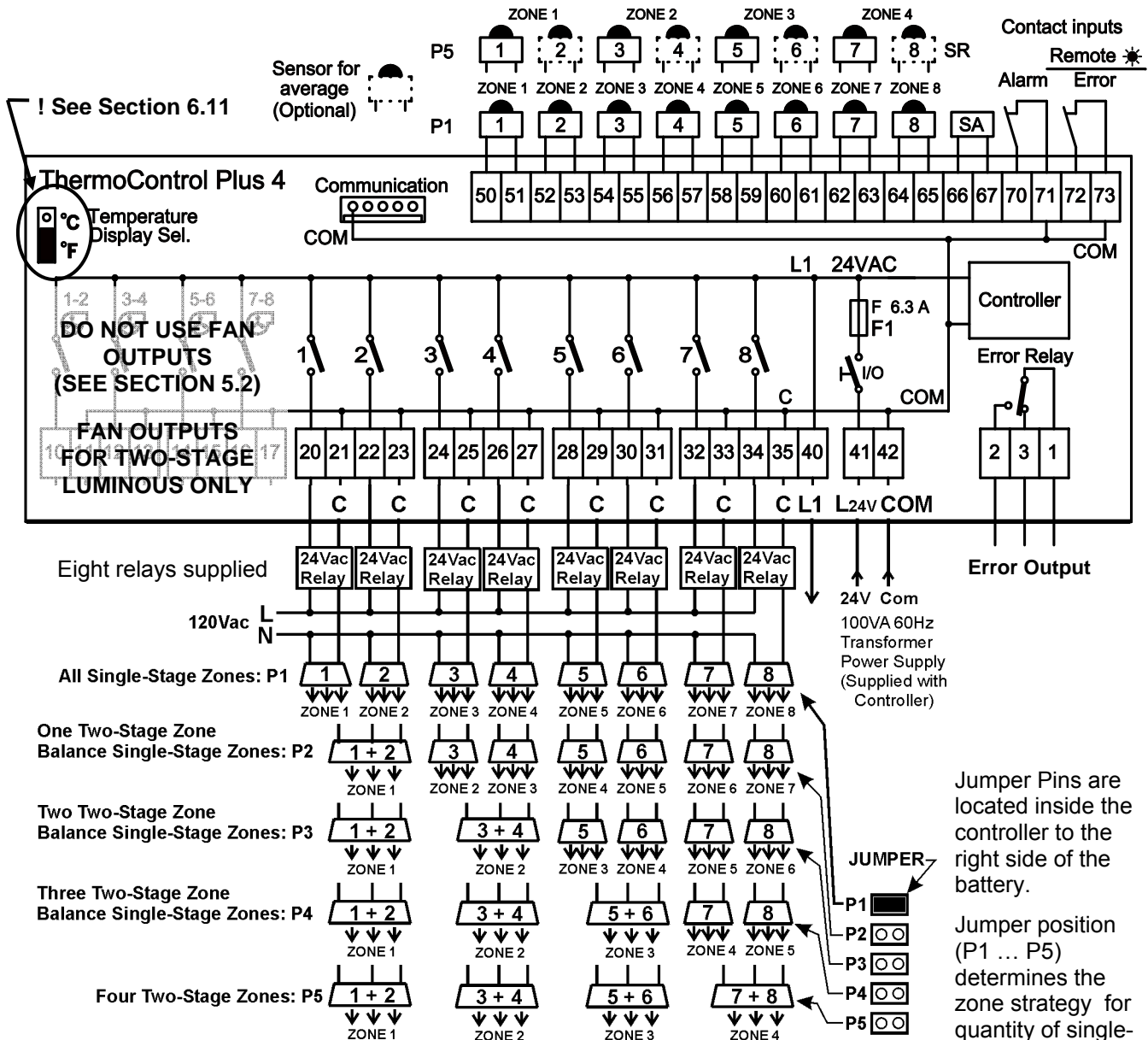

Jumper Pins are located inside the controller to the right side of the battery.

Jumper position (P1 ... P5) determines the zone strategy for quantity of single-

6.5 Zone Configuration – Two Stage Tube Heaters

For two-stage tube heaters: All heater zones are set up as two-stage only. Pairs of controller outputs control low and high fire. The location of the jumper in P5 establishes four two-stage zones. A 100VA 120V/24V transformer is supplied to power the controller, and eight 24Vac external relays are also supplied. Additional field supplied items required for EACH two-stage zone: Qty 1 x 100 VA 120V/24V transformer; Qty 2 x external zone relays (one Low-stage + one High-stage); Qty 2 per heater in zone x external heater relays (one Low-stage + one High-stage). Refer to configuration diagram below and wiring diagram for two-stage tube heaters.

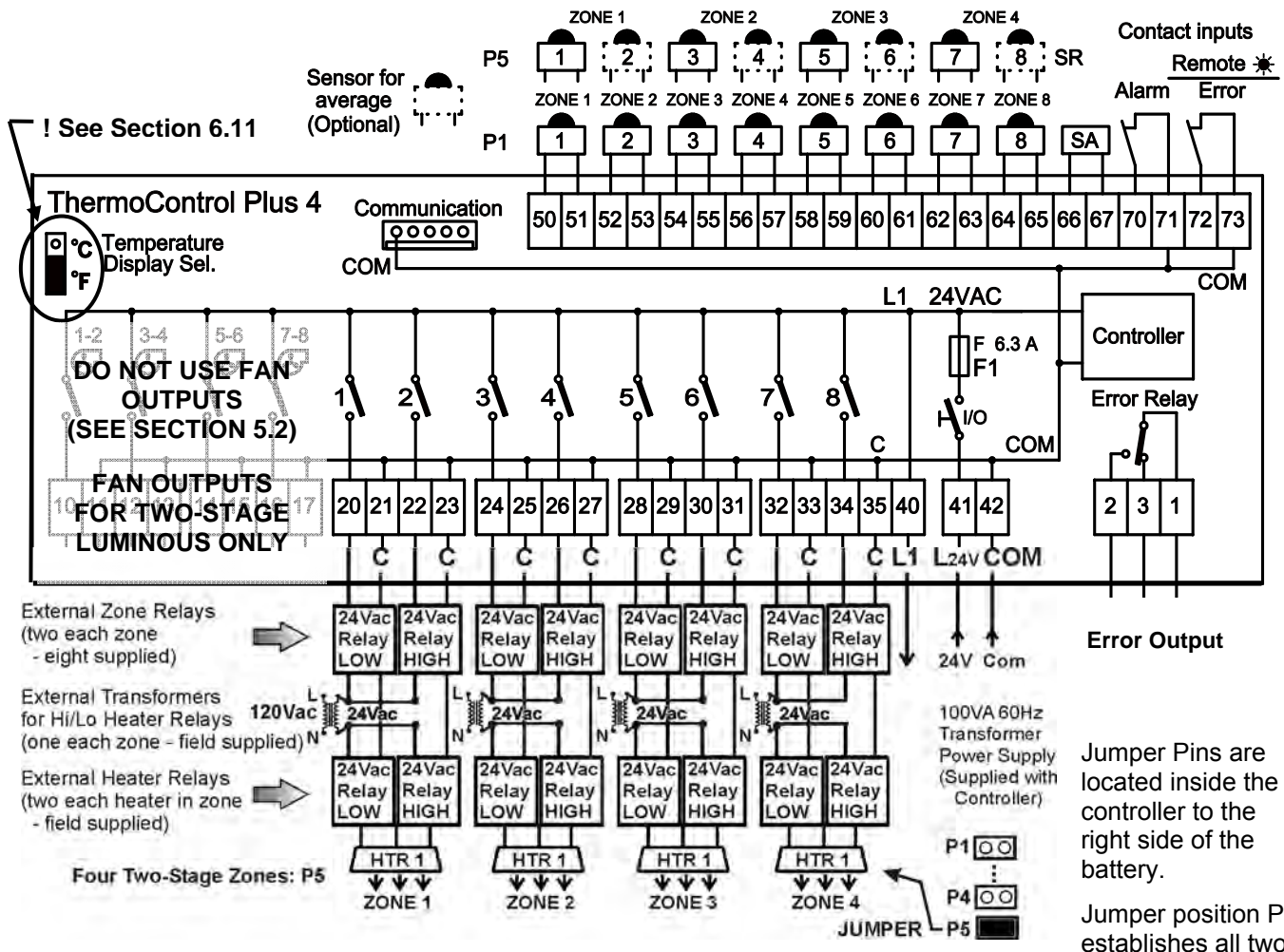

6.6 Zone Configuration – Luminous (high intensity) Heaters

A luminous heater has a 24Vac ignition control module and gas valve. While individual heaters are single-stage, heater zones can be set up as single-stage, or two-stage. Two-stage zones have a proportion of the heaters on low-stage, with the balance of the heaters in the zone on high-stage. The quantity of luminous heaters in a zone is typically limited by: the dimensional size of the zone; capacity of exhaust fan to satisfy the total input of the zone.

The location of the jumper in P1 ... P5 determines the quantity of single-stage and two-stage zones. For single stage zones, zone relays (eight supplied) switch line voltage to field supplied exhaust fan and transformer in each zone. Heating zone required exhaust volume is:

USA: 4 cfm/1,000 Btuh input; Canada: 300 cfm/100,000 Btuh input. Zone transformer sizing: 40VA first heater + 20VA each additional heater in zone.

The configuration diagrams below indicate the single- and two stage zone strategies for Jumper positions P1 to P5. Also refer to the wiring diagram for luminous heaters.

6.6.1 Zone Configuration – Luminous (high intensity) Heaters

JUMPER IN POSITION 1 (P1): Up to eight single stage zones (all single-stage)

The jumper pins P1 to P5 are located inside the controller cover to the right side of the battery. The location of the jumper in P1 ... P5 determines the quantity of single-stage and two-stage zones.

With the jumper in position P1, all zones are single stage. Eight relay switches are supplied with the controller to switch line voltage to the zone exhaust fans (field supplied) and to the zone transformers (field supplied). Single-stage zones are controlled by the heater outputs 20-35. Single-stage zone exhaust fans are wired in parallel to the heater zone transformer.

The 120V/24Vac zone transformer is 'sized' to provide sufficient power to all heaters in the zone: 40VA for first heater + 20 VA for each additional heater.

Refer to the diagram below, and the wiring diagram "Luminous Heaters – Single-Stage Zones".

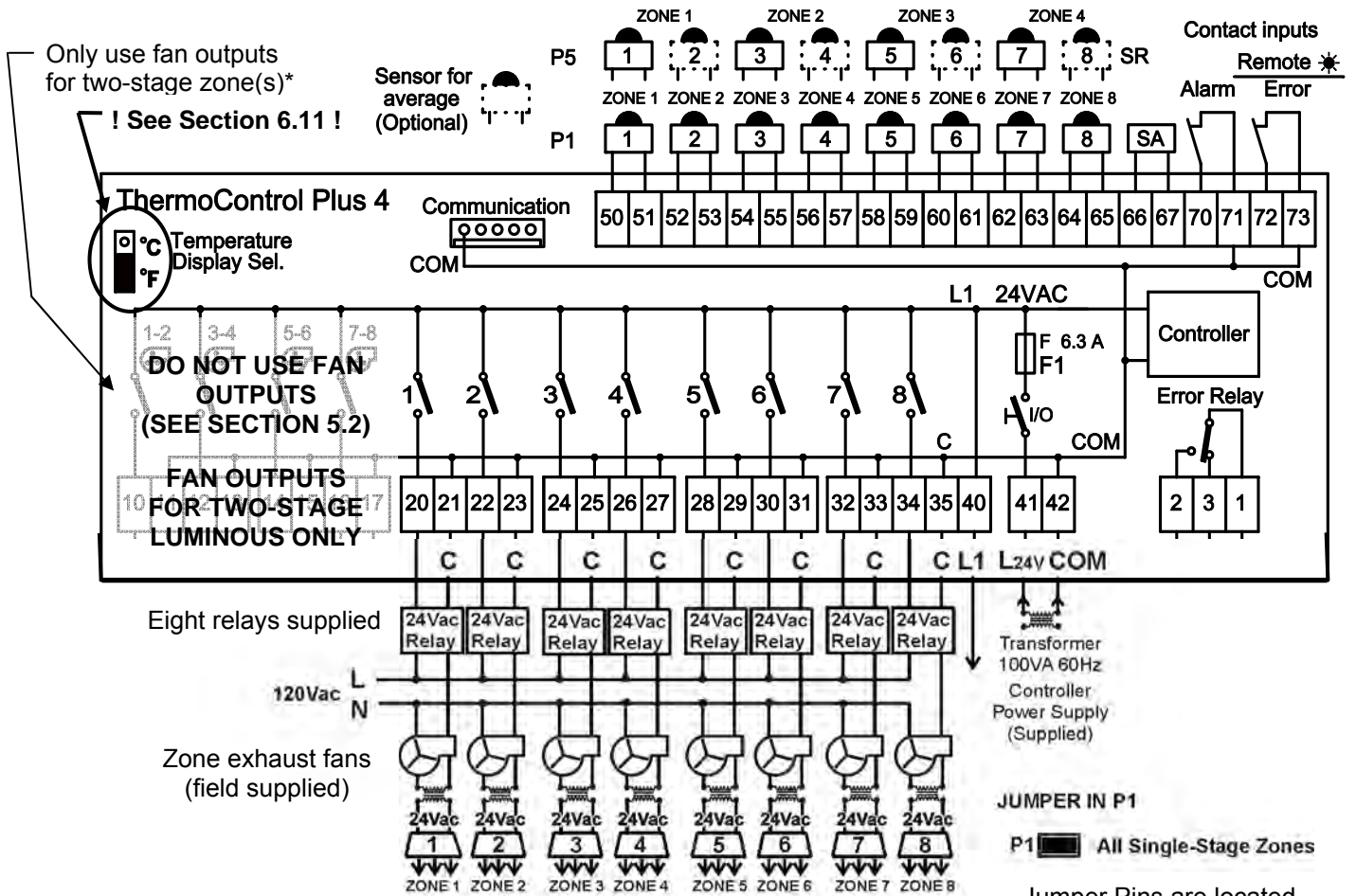

Jumper Pins are located inside the controller to the right side of the battery

6.6.2 Zone Configuration – Luminous (high intensity) Heaters

JUMPER IN POSITION 2 (P2): One two-stage zones + up to six single-stage zones

The jumper pins P1 to P5 are located inside the controller cover to the right side of the battery. The location of the jumper in P1 ... P5 determines the quantity of single-stage and two-stage zones.

With the jumper in position P2, one zone is two-stage, and the balance of the zones are single stage. Eight relay switches are supplied with the controller to switch line voltage to the zone exhaust fans (field supplied) and to the zone transformers (field supplied). One additional field supplied relay switch (P/N: JS-0568-CC) is required to power the exhaust fan for the two-stage zone.

The fan for the two-stage zone is controlled by the controller fan outputs 10-11. Fans for the single-stage zones are controlled by the heater outputs 24-35. Single-stage zone exhaust fans are wired in parallel to the heater zone transformer.

The 120V/24Vac zone transformer is 'sized' to provide sufficient power to all heaters in the zone: 40VA for first heater + 20 VA for each additional heater. A separate transformer is required for each of the Low- and High-stage zones in two-stage Zone 1.

Refer to the diagram below, and the wiring diagram "Luminous Heaters – Two-Stage Zone".

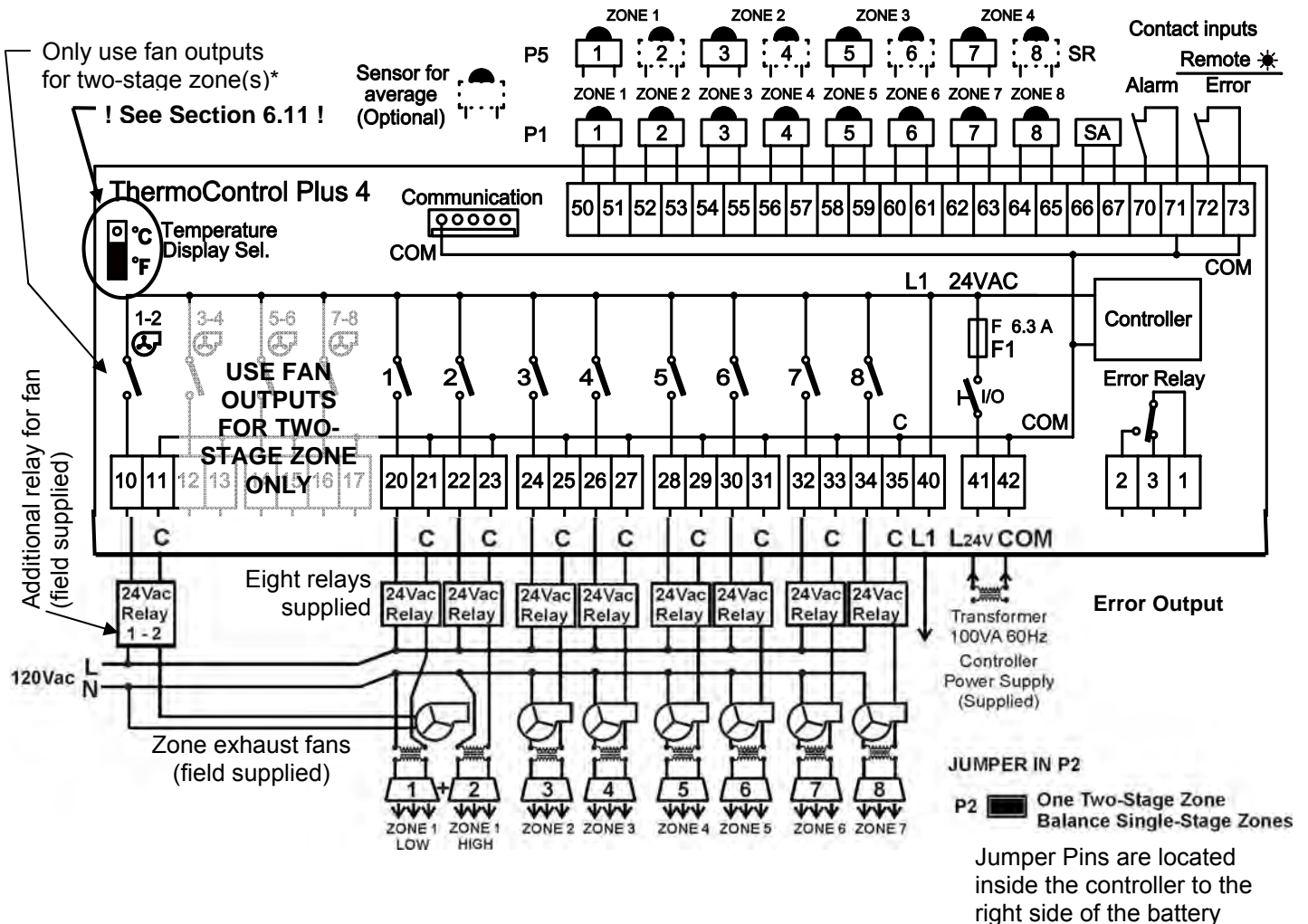

6.6.3 Zone Configuration – Luminous (high intensity) Heaters

JUMPER IN POSITION 3 (P3): Two two-stage zones + up to four single-stage zones

The jumper pins P1 to P5 are located inside the controller cover to the right side of the battery. The location of the jumper in P1 ... P5 determines the quantity of single-stage and two-stage zones.

With the jumper in position P3, two zones are two-stage, and the balance of the zones are single stage. Eight relay switches are supplied with the controller to switch line voltage to the zone exhaust fans (field supplied) and to the zone transformers (field supplied). Two additional field supplied relay switches (P/N: JS-0568-CC) are required to power the exhaust fans for the two-stage zones.

The fans for the two-stage zones are controlled by the controller fan outputs 10-11 and 12-13. Fans for the single-stage zones are controlled by the heater outputs 28-35. Single-stage zone exhaust fans are wired in parallel to the heater zone transformer.

The 120V/24Vac zone transformer is 'sized' to provide sufficient power to all heaters in the zone: 40VA for first heater + 20 VA for each additional heater. A separate transformer is required for each of the Low- and High-stage zones in two-stage Zones 1 and 2.

Refer to the diagram below, and the wiring diagram "Luminous Heaters – Two-Stage Zone".

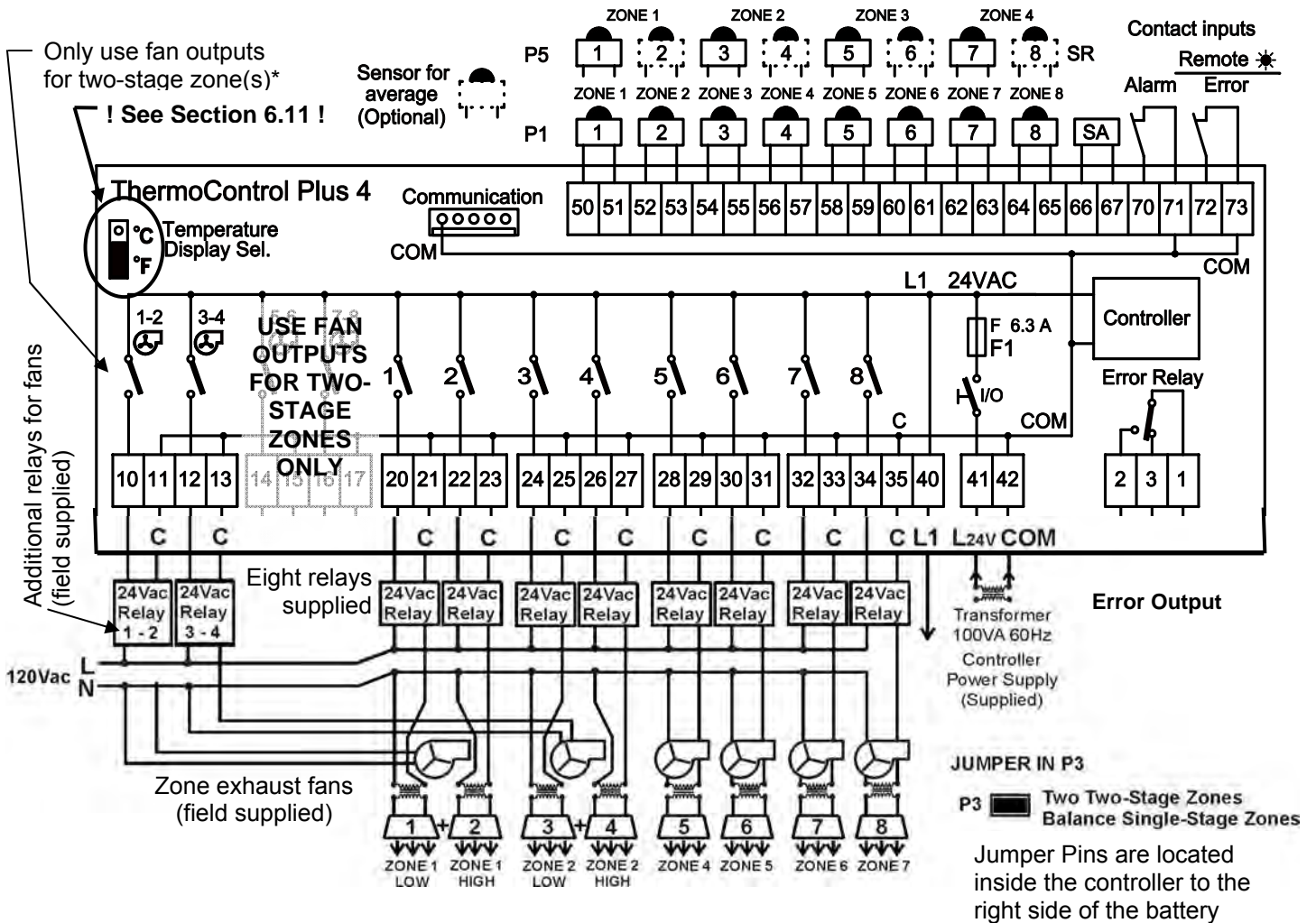

6.6.4 Zone Configuration – Luminous (high intensity) Heaters

JUMPER IN POSITION 4 (P4): Three two-stage zones + two single-stage zones

The jumper pins P1 to P5 are located inside the controller cover to the right side of the battery. The location of the jumper in P1 ... P5 determines the quantity of single-stage and two-stage zones.

With the jumper in position P4, three zones are two-stage, and two zones remain for single stage. Eight relay switches are supplied with the controller to switch line voltage to the zone exhaust fans (field supplied) and to the zone transformers (field supplied). Three additional field supplied relay switches (P/N: JS-0568-CC) are required to power the exhaust fans for the two-stage zones.

The fans for the two-stage zones are controlled by the controller fan outputs 10-11, 12-13 and 14-15. Fans for the single-stage zones are controlled by the heater outputs 32-35. Single-stage zone exhaust fans are wired in parallel to the heater zone transformer.

The 120V/24Vac zone transformer is 'sized' to provide sufficient power to all heaters in the zone: 40VA for first heater + 20 VA for each additional heater. A separate transformer is required for each of the Low- and High-stage zones in two-stage Zones 1 and 2.

Refer to the diagram below, and the wiring diagram "Luminous Heaters – Two-Stage Zone".

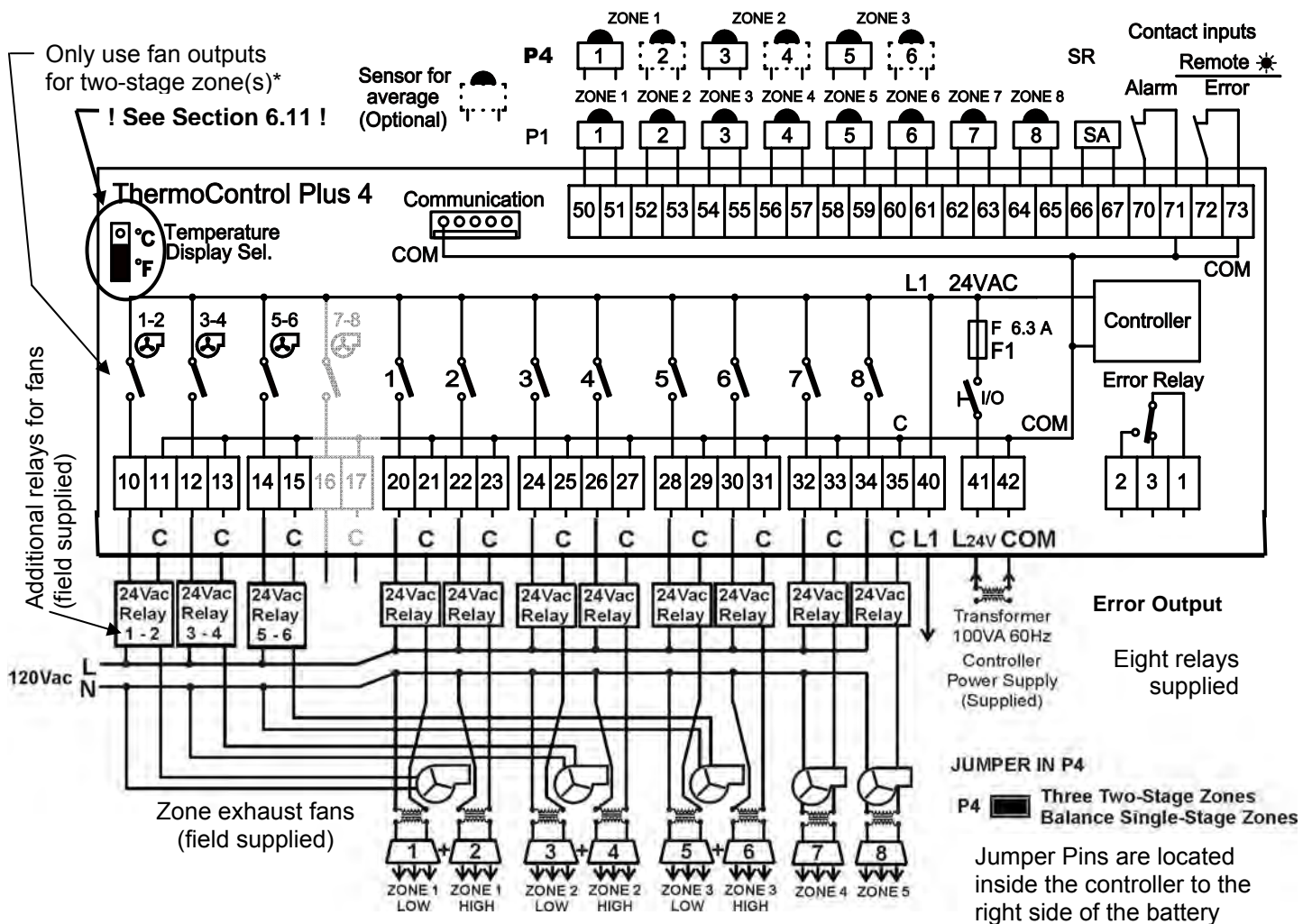

6.6.4 Zone Configuration – Luminous (high intensity) Heaters

JUMPER IN POSITION 5 (P5): Four two-stage zones

The jumper pins P1 to P5 are located inside the controller cover to the right side of the battery. The location of the jumper in P1 ... P5 determines the quantity of single-stage and two-stage zones.

With the jumper in position P5, all four zones are two-stage. Eight relay switches are supplied with the controller to switch line voltage to the zone transformers (field supplied). Four additional field supplied relay switches (P/N: JS-0568-CC) are required to power the exhaust fans for the two-stage zones.

The fans for the two-stage zones are controlled by the controller fan outputs 10-11, 12-13, 14-15 and 16-17.

The 120V/24Vac zone transformer is 'sized' to provide sufficient power to all heaters in the zone: 40VA for first heater + 20 VA for each additional heater. A separate transformer is required for each of the Low- and High-stage zones in each of the 4two-stage zones.

Refer to the diagram below, and the wiring diagram "Luminous Heaters – Two-Stage Zone".

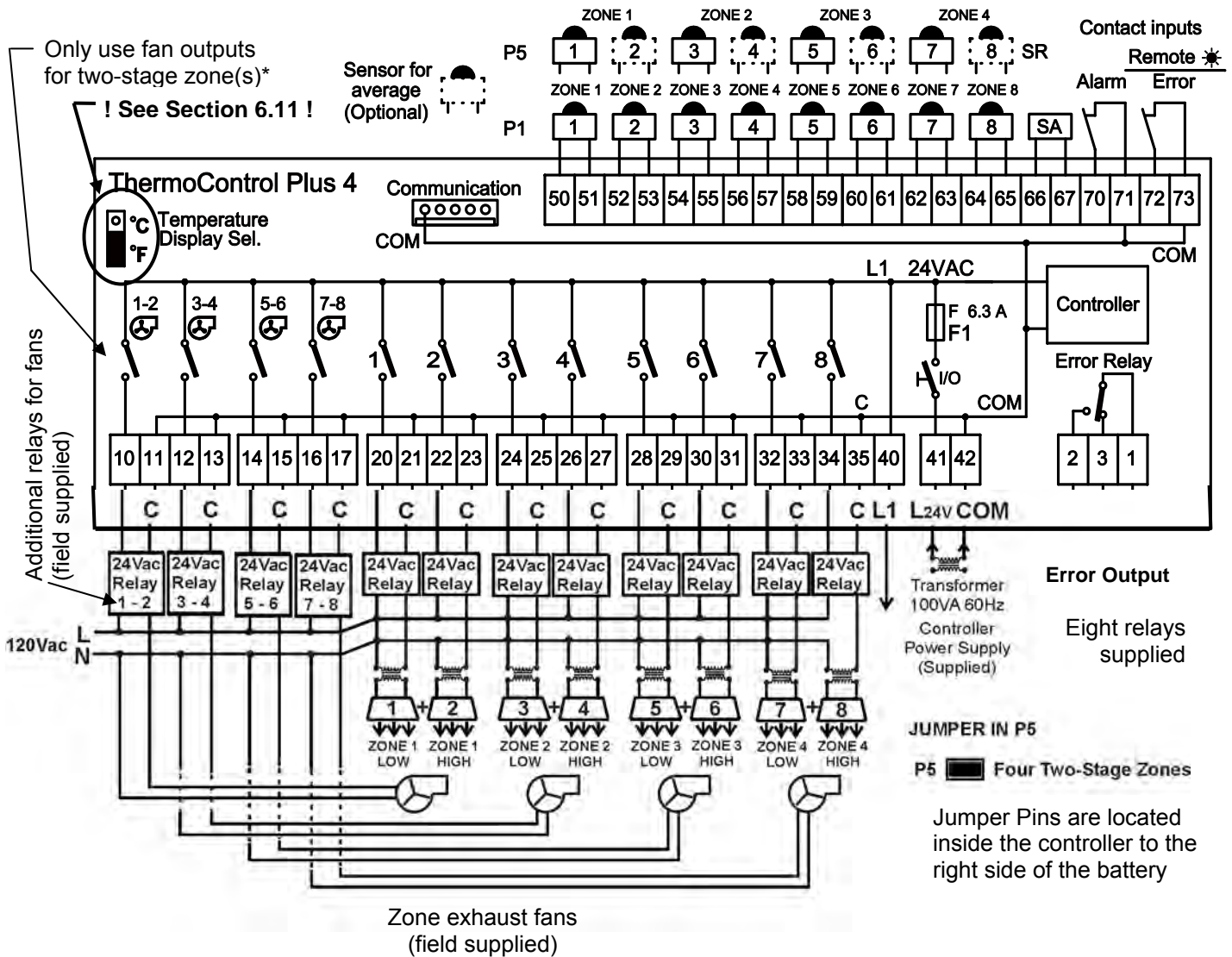

6.7 Exhaust fan output connection – For Two-stage Luminous Zone ONLY

REFER TO ZONE AND EXHAUST FAN SCHEMES IN 6.6 AND LUMINOUS HEATER WIRING DIAGRAM. Exhaust fan output connections (10 to 17) are reserved for luminous two-stage zones ONLY! Use 24VAC Class 2 rated power relay (field supplied) to switch line voltage to an exhaust fan that serves both the proportion of heater in the low-stage zone, and the balance of the heaters in the high-stage zone.

Two control circuit outputs belong to one common exhaust fan control output. For example: connections 10-11 is the common exhaust fan for heating outputs 20-23 = zone 1-Low and zone 1-High. If one or both heating zone outputs are activated, the exhaust fan output will be activated also. When both heating zone outputs switch off, the exhaust fan also switches off immediately or can be delayed (run on) to switch off after a programmable period of time (chapter 5.2). For single stage zones the exhaust fan is controlled by the heater outputs 20-35 and the exhaust fan outputs should be locked off (chapter 5.2).

6.8 Alarm contact input (e.g.: Fire Alarm system input, etc.)

Connect dry contact to this input. **The contact must be provided by low voltage Class 2 rated equipment.** If the dry contact is interrupted, the controller switches off all heaters and exhaust fans independently. At the same time “ERROR” starts to blink on the display and the “ALr” symbol appears in the display. If the contact is not used, bypass the connections.

6.9 Remote-Control ☀

Connect dry contact to this input. **The contact must be provided by low voltage Class 2 rated equipment.**

The feature Remote-Control can be selected in the SETUP-Menu (5-2). The controller switches to day mode ☀ in both zones, if the remote contact is activated. The display shows the ☀ symbol. If the remote contact is not used, bypass the connections.

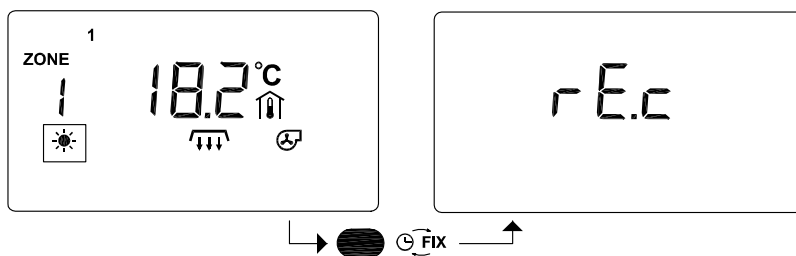

If the remote contact is activated it is not possible to change the operating mode by using the  button. A warning signal "rE.c" (remote contact) appears in the display.

6.10 Signal input fault

Connect dry contact to this input. **The fault signal must be provided by low voltage Class 2 rated equipment.**

The feature contact input fault can be selected in the SETUP-menu (5-2). The external error message can be connected to inputs 72-73. In case of an error message (option) the signal ERR and RES as well as ERROR light begins to blink. At the same time the Error relay switches on. The operation mode of the controller is not changed due to the error signal.

6.11 Temperature display °F / °C selection

Switch off main power supply before making any changes to this jumper! Select the °F / °C temperature display mode by jumper location (see figure 6.4 Wiring Connection). After selecting the readout all displays and settings will automatically appear with the selected mode. Factory setting of this selection is °F. Set values for °F / °C are stored separately - after modifying selection you must set actual values (no automatic conversation here).

6.12 Communication connection

Two types of optional communication cards can be used and connected to the "Communication" terminal (only one type can be used at a time):

-**CM485** card: Modbus (RS485) output, standard interface to building and industrial supervisory systems. The output of this card is optically isolated from the controller.

-**CM232** card: RS232 output, built-in 3-weeks data logger. Direct connection to telephone modem or PC. Stored data can be downloaded to PC, remote setting of the controller from the PC.



The signal output ground of the CM232 module is directly connected to the controller's common ground "COM". If the signal line of the connected computer is grounded, the common ground "COM" of the controller will be grounded as well. This will change state from isolated to grounded.

6.13 Common fault signal

In case of any operational error the red "ERROR" symbol starts to blink, simultaneously the error relay switches on (connections 1, 2, 3). The display shows the affected control zone. Type and cause of the problem is also indicated by other symbols displayed. To select another control zone press "ZONE" - in doing so, the red "ERROR" signal won't disappear, because the cause of the problem is not yet solved. The blinking "ERROR" signal and the activated error relay can be deactivated by switching off the operational function of the zone using the \cup/\cup button.

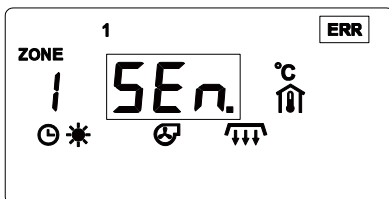

Sensor error: The temperature sensor or is not properly connected. It is damaged or short-circuited. Verify connections and wires. In case of any sensor error the controller does not switch off the heater zone (relay output is kept activated).

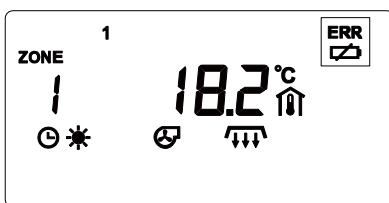

Battery error: Battery low or discharged. Replace the battery immediately. The battery is located inside the control unit cover. Type: 1.5V (AA). Use long-life batteries. Before changing the batteries please read the general security instructions – and in particular Section 4.4.4!

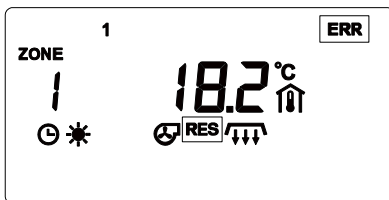

This is an error message (option) of a heater (connections 72-73). The operation mode of the controller is not changed due to the error signal.

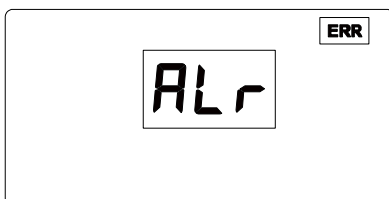

Alarm signal: Does not point out the kind of operational error. It only shows that an error message has arrived at the "alarm contact". The controller switches off all heaters and exhaust fans. If the "alarm contact" is not used the connections should be bypassed.

This display is a very rare error: a forced position of a button at the front panel. Please check!

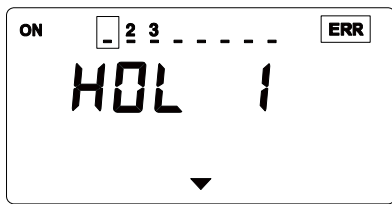

Holiday Programming: When modifying the holiday program the “ERROR” signal will appear if the starting(A) or ending(B) dates or calendar data are in conflict. (for example: the end date is earlier than the start date of a holiday period) In case of data entry error, the holiday program won’t activate.

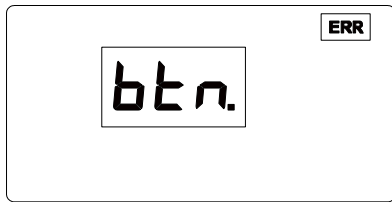

This display represents a very rare error: a button on the front panel is jammed in the depressed position. Please check button orientations!

7 Technical

Relay outputs: 8 control relays - up to 8 heating zones, (4 flue fan relays – Reserved – Do Not Use).

Relays switch out 24Vac to connection terminals (wet contact).

1 error relay: connected as voltage-free contact to connection terminals

Relay load: max. 6.3A 24V 50/60Hz (inductive)

Inputs: Temperature sensors: 2-wire connection

SR - black-bulb IR/Ambient temperature sensor (NTC)

OAS - outside ambient temperature sensor (NTC)

Contact inputs: potential free contacts, closed if not used

Connected appliances must meet low voltage Class 2 requirements

Alarm contacts

Remote ☀: Forced day mode operation or Signal input fault contacts (selectable)

Set values: The values of each zone can be modified separately:

Type: Day mode: ☀ +3...+35 °C / 37...95 °F

Night mode: ☾ +3...+35 °C / 37...95 °F

Freeze Protection mode: * +3...+20 °C / 37...68 °F

Holiday program: 8 programmable holiday periods (calendar dates)

Application: Luminous and tube type gas-fired radiant heaters; programmable

Hysteresis Δ : 0.2 ... 2.0 °C / 0.4 ... 3.6 °F

Integration band: (two-stage operation only): 0.5 ...3.0 °C / 1.0...5.5 °F

Integration time: (two-stage-heater operation only): 10 ... 99 minutes

Sensor correction: -9.9...+10.0 °C / -9.9...+10.0 °F

Exhaust fan delay (run on) time: 0 60 minutes

Clock, calendar: Real-time clock with calendar

Clock power: 1.5 V AA battery, durability: ~ 3 years

automatic summer / winter time correction (+/- 1 hour):

can be deactivated

correction to summer time: second Sunday in March

correction to winter time: first Sunday in November

Time programs: Independent weekly program in each zone:

19 switching points

Saved on internal EEPROM-memory

Power supply: 24V+-20% 50/60Hz (terminals L 24V, Com) P_{max} (controller): 10 VA

Must use Class 2 rated power supply

Fuse: F1 5x20mm 6.3 A (F) standard

Connections: Screw terminals, wire section max.: 11 AWG

Safety standards: UL 60950

Operating temperature: 0...50 °C / 32...122 °F

Storage temperature: -10...60 °C / 14...140 °F

Protection: NEMA13 / IP65

Housing: Plastic housing with transparent door (key lock); waterproof; UV-resistant

Dimensions: 10-3/4" x 8-5/8" x 5-3/8" (275 x 220 x 140 mm)

8 WIRING DIAGRAMS - ThermoControl Plus 1, 2, 4

8.1 Standard Tube Heaters:

- Single-stage zone; 1-8 Zones
- Two-stage zones; 1-4 Zones (refer to section 5 and 5.2)
 - Wire each of the low- and high-stage zones as below
 - Jumper position and controller programming determine two-stage operation

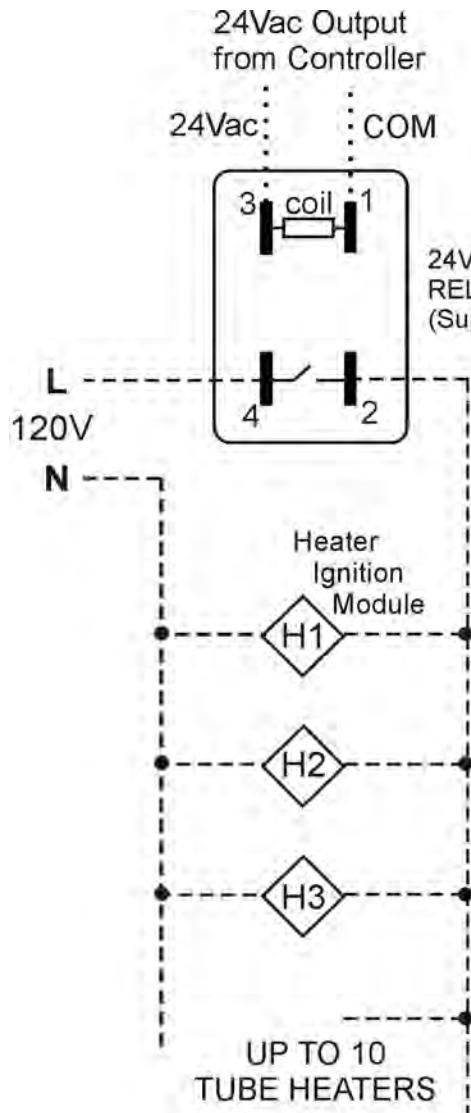

NOTES:

- Refer to manual of specific tube heater model for internal wiring diagram
- Sufficient relay switches are supplied for control of standard tube heater zones
- Power supply: Provide disconnect means and overload protection as required by local and/or national code

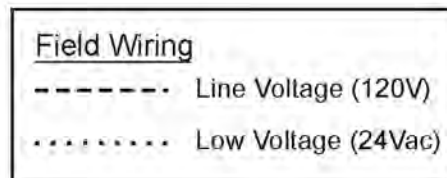

8.2 Two-Stage Tube Heaters: 1-4 two-stage zones

(refer to section 5 and 5.2)

See internal burner wiring diagram next page

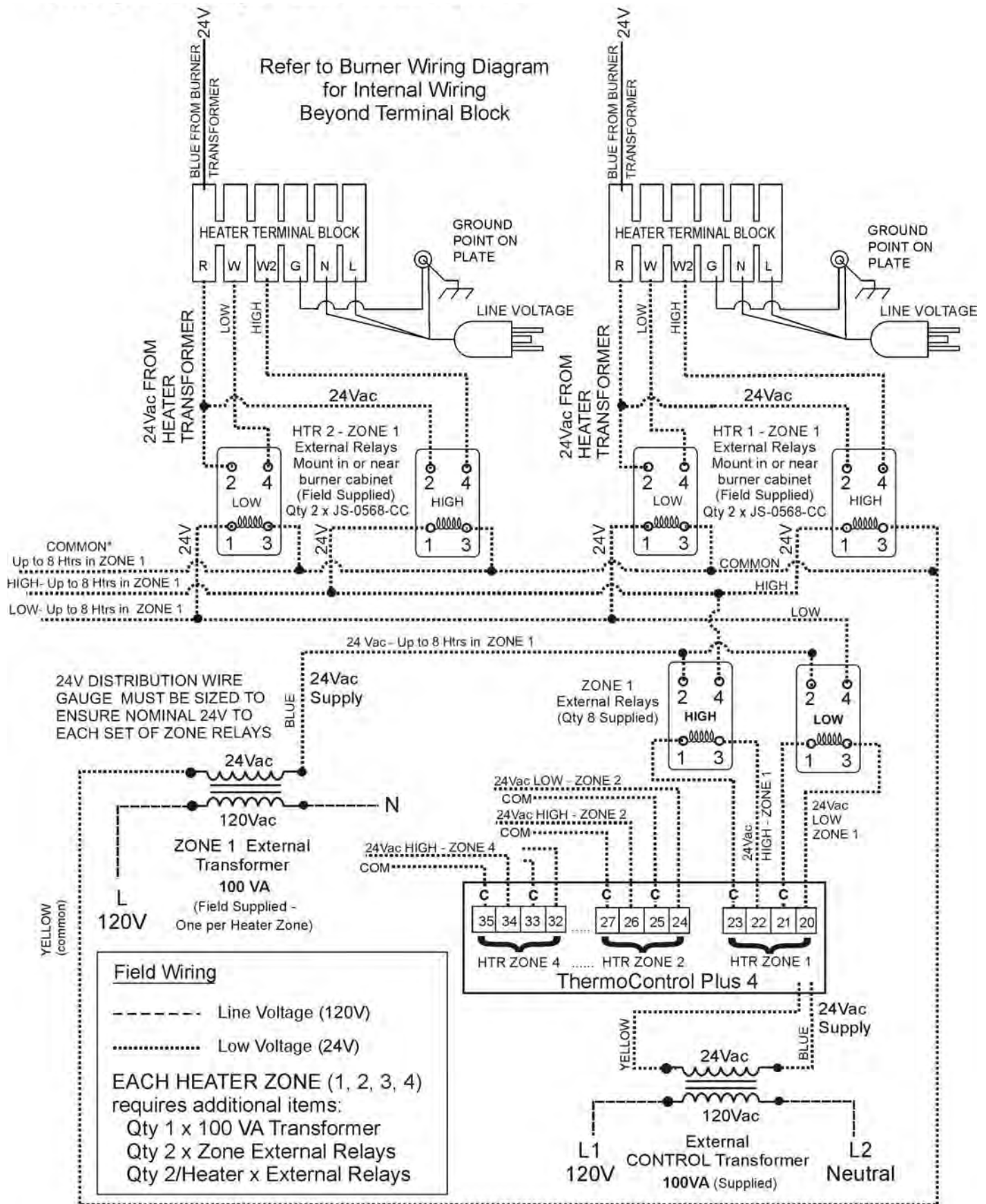

8.2.1 Two-Stage Tube Heater Internal Burner Wiring

See zone wiring diagram previous page

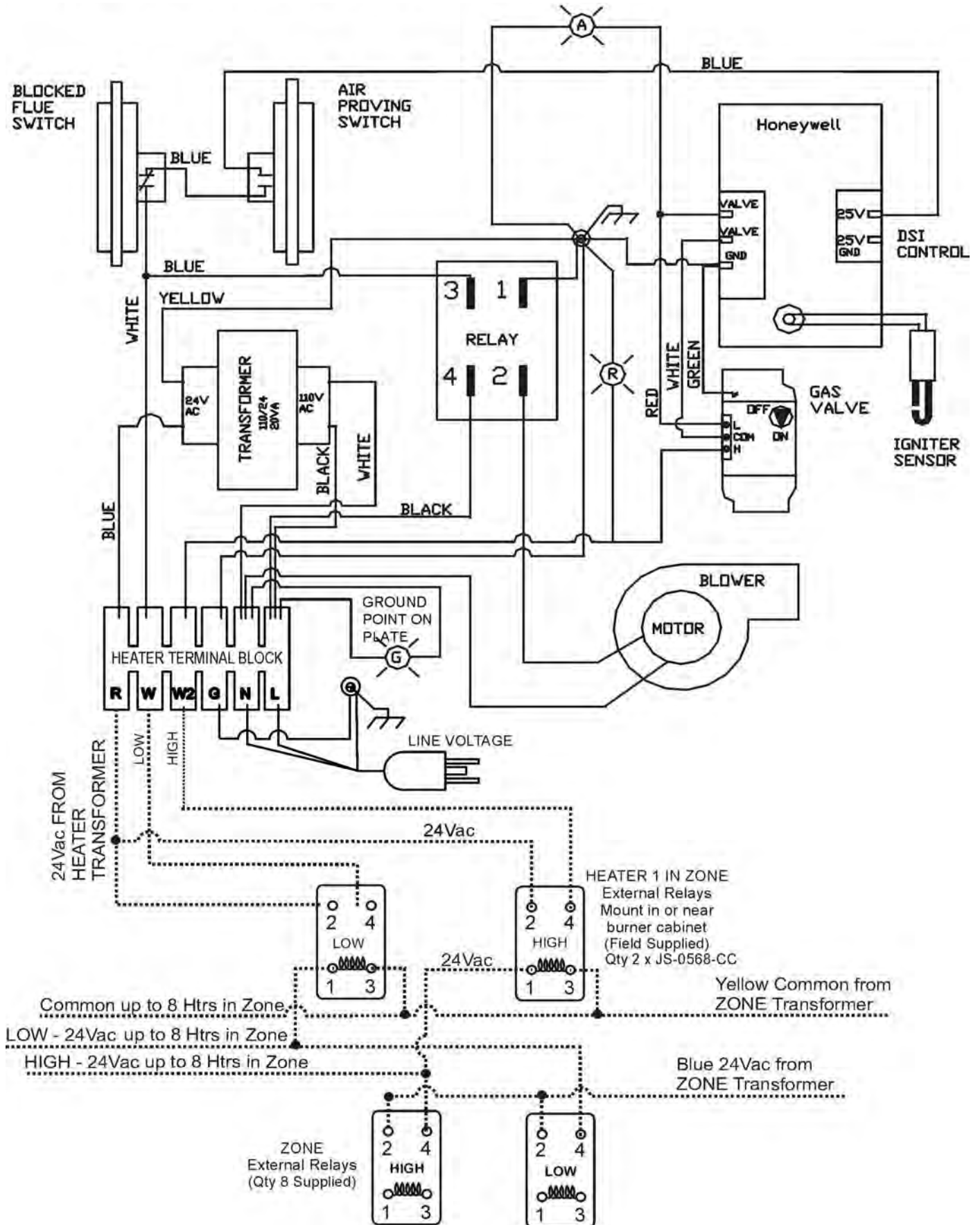

8.3 Luminous Heaters: single-stage; 1-8 Zones

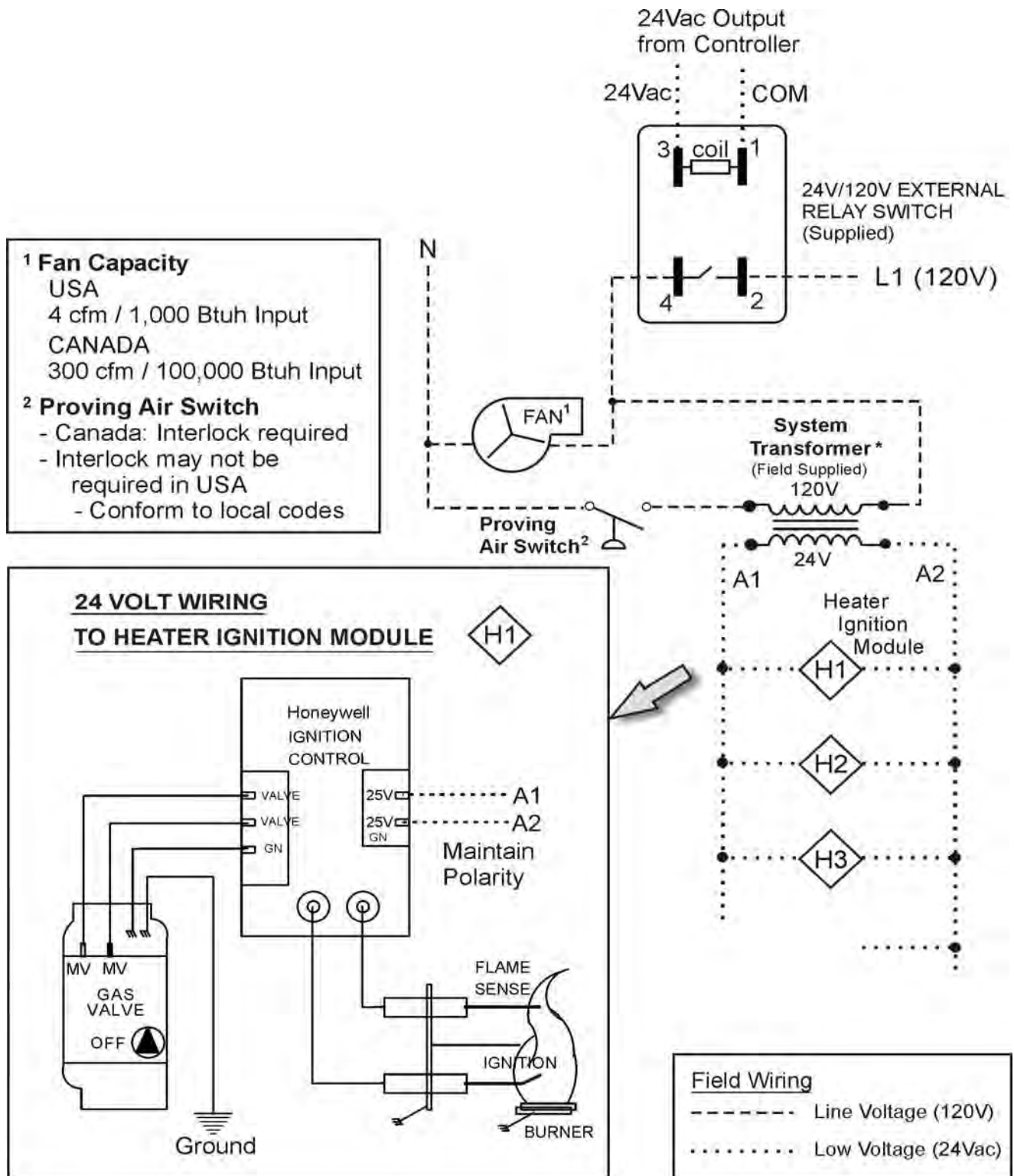

Note: Power supply: Provide disconnect means and overload protection as required by local and/or national code..

Maintain polarity at control modules.

* Size system transformer: 40VA first heater + 20VA each additional heater

8.4 Luminous Heaters: Two-stage Zones; 1-4 Zones

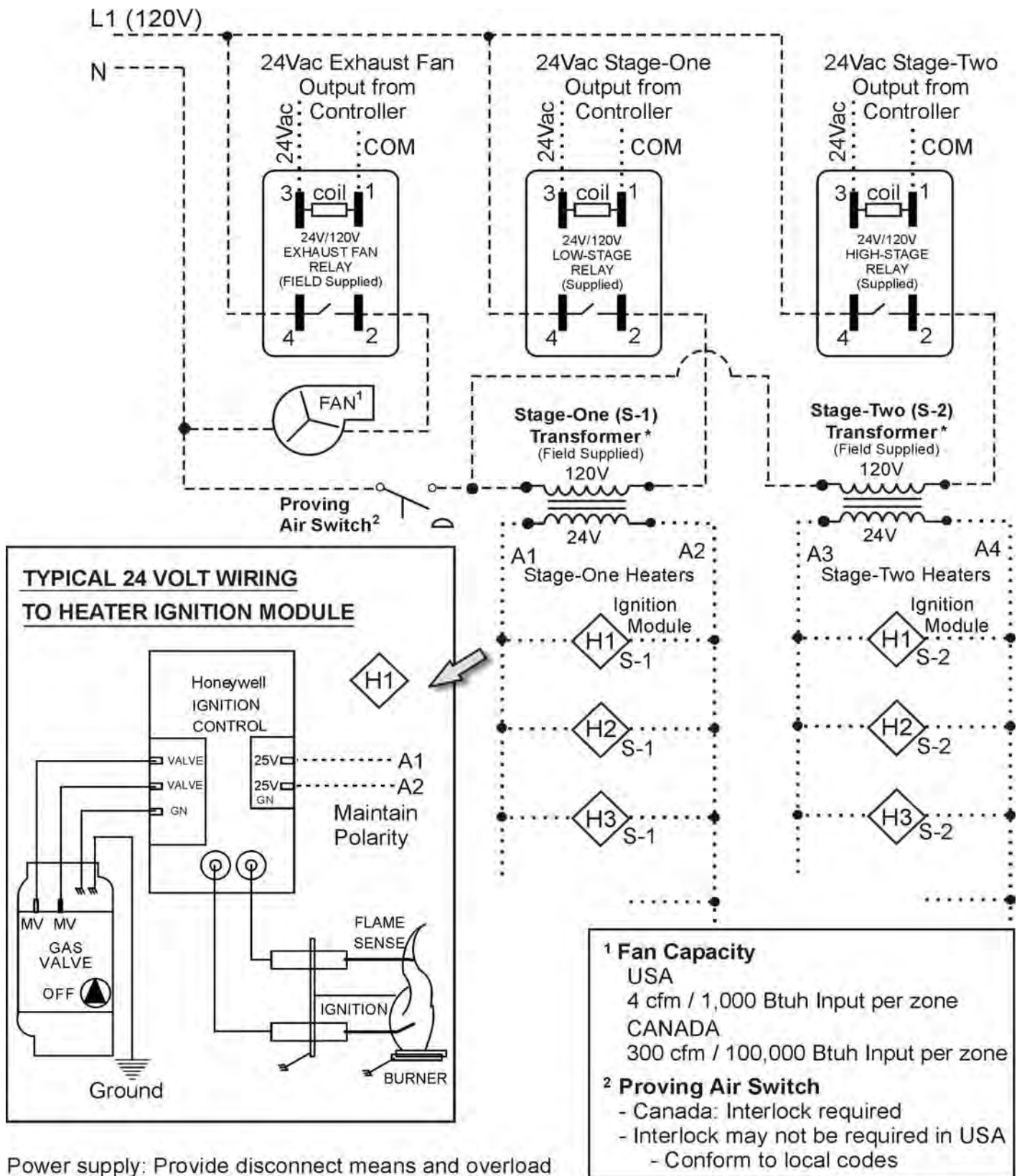

Power supply: Provide disconnect means and overload protection as required by local and/or national code.

Maintain polarity at control modules.

* Size heater transformer:

40VA first heater + 20VA each additional heater

Field Wiring

----- Line Voltage (120V)

..... Low Voltage (24Vac)

8.5 Wiring diagram, accessories

Option 1: Override Button

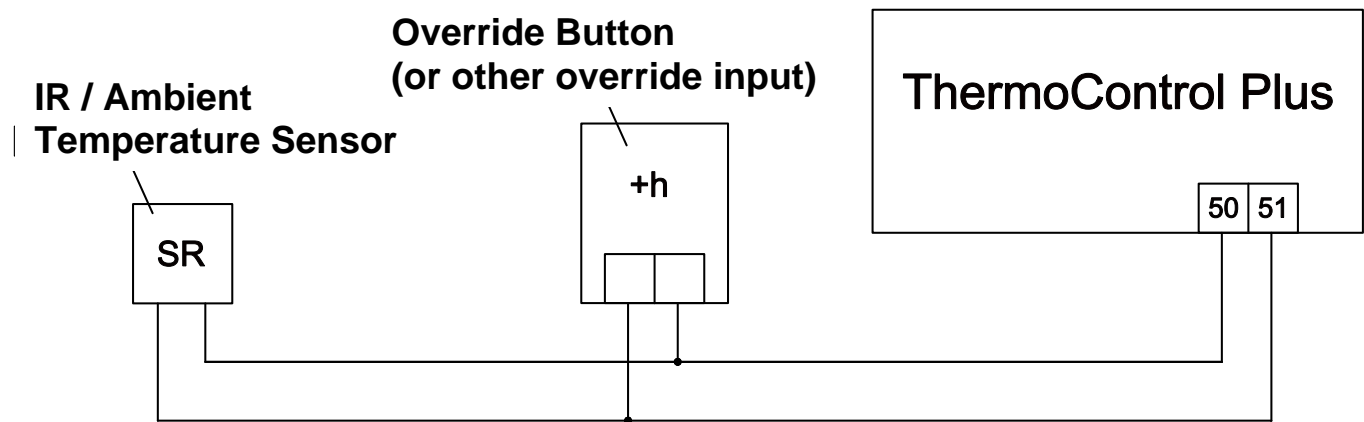

NOTE: For humidity control (steel storage facilities, etc.) a humidity sensor can be connected in parallel to the SR to operate the heaters if humidity rises above humidity set-point even though temperature set-point may be satisfied.

Other inputs such as coin-operated equipment can also be connected in parallel to the SR.

Option 2: Average temperature determination, Four SR sensors

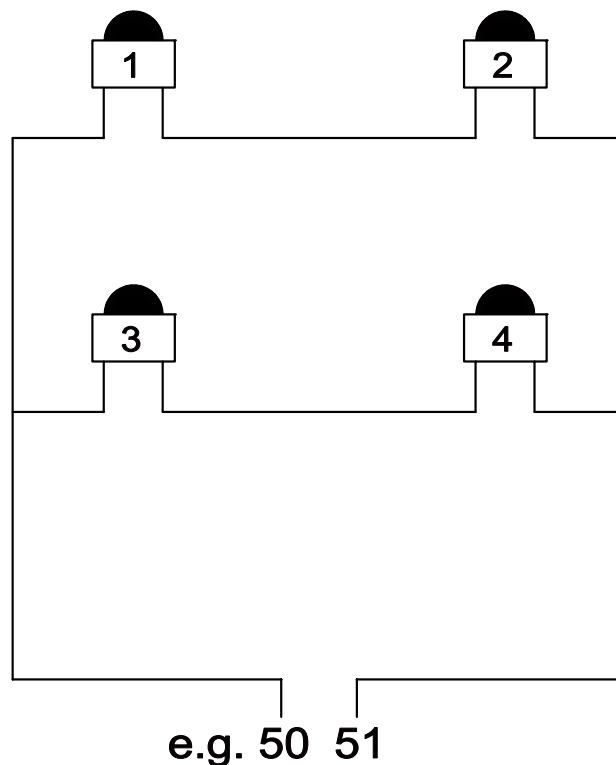

8.6 Temperature Sensor-Characteristics

°F	OHM
32	14324
34	13539
36	12802
38	12110
40	11460
42	10848
44	10273
46	9732
48	9223
50	8744
52	8293
54	7867
56	7466
58	7088
60	6732
62	6395
64	6078
66	5778
68	5495
70	5227
72	4974
74	4735
76	4509
78	4295
80	4092
82	3900
84	3718
86	3546

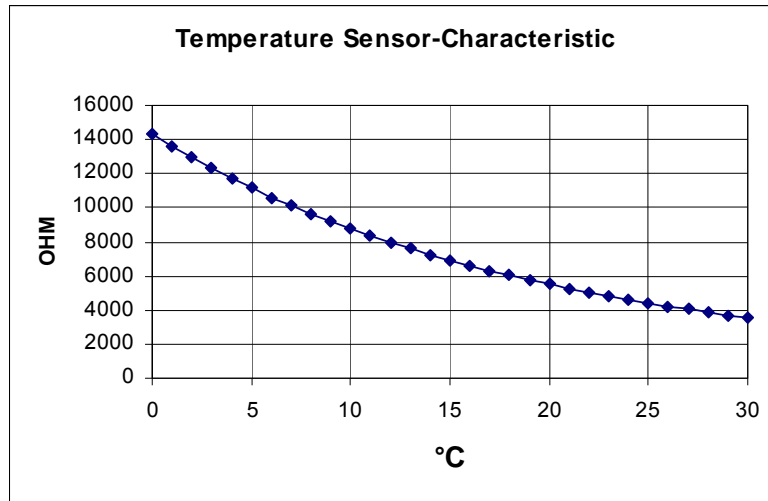
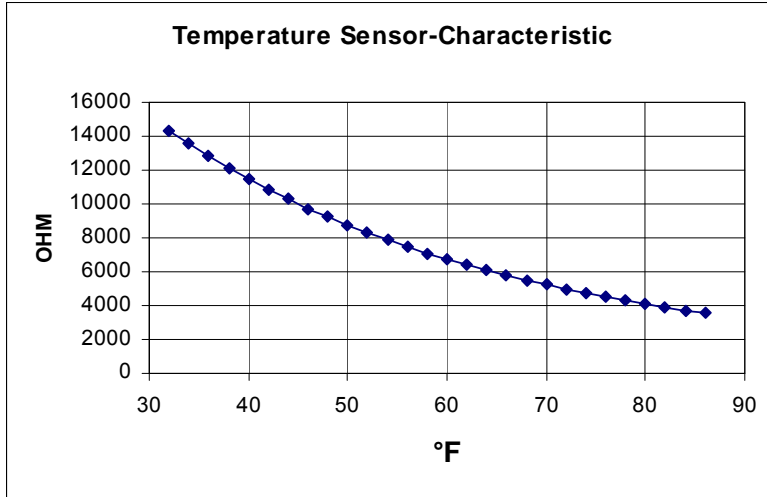

°C	OHM
0	14324
1	13615
2	12946
3	12313
4	11715
5	11149
6	10614
7	10107
8	9628
9	9174
10	8744
11	8336
12	7950
13	7584
14	7237
15	6907
16	6595
17	6298
18	6016
19	5749
20	5495
21	5253
22	5024
23	4805
24	4598
25	4400
26	4212
27	4033
28	3863
29	3701
30	3546